

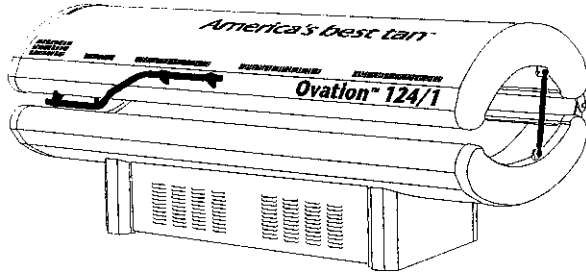

4251 N.E. Port Drive  
Lee's Summit, MO 64064  
800-554-8268

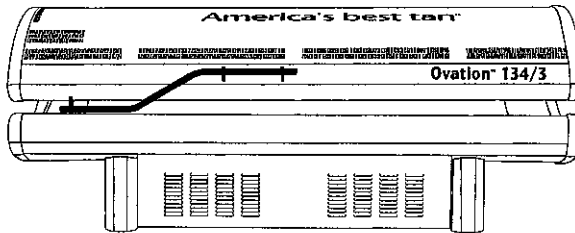

124, 124/1



128, 128/1  
134, 134/3, 134VLR, 134/3VLR, 134C

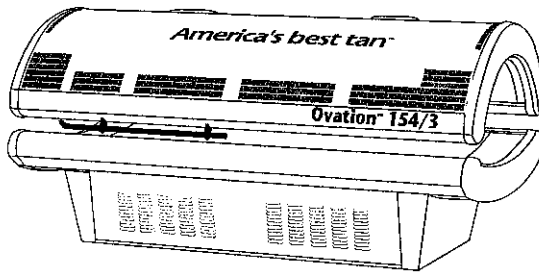

144, 144/3  
154, 154/3



## Owner & Assembly Manual

Les Spécifications Françaises Enclos

# Table Of Contents

|                |   |
|----------------|---|
| <b>3</b>       | <b>.....Welcome</b>   |
| <b>4 - 6</b>   | <b>.....154 and 154/3 12MINUTE Specifications/Exposure Schedule</b>                     |
| <b>7 - 9</b>   | <b>.....154 and 154/3 15MINUTE Specifications/Exposure Schedule</b>                     |
| <b>10 - 12</b> | <b>.....144 and 144/3 Specifications/Exposure Schedule</b>                              |
| <b>13 - 15</b> | <b>.....134 and 134/3 Specifications/Exposure Schedule</b>                              |
| <b>16 - 18</b> | <b>.....134VLR and 134/3VLR Specifications/Exposure Schedule</b>                        |
| <b>19 - 21</b> | <b>.....134C Specifications/Exposure Schedule</b>                                       |
| <b>22 - 24</b> | <b>.....128 and 128/1 Specifications/Exposure Schedule</b>                              |
| <b>25 - 27</b> | <b>.....124 and 124/1 Specifications/Exposure Schedule</b>                              |
| <b>28</b>      | <b>.....Warnings And Cautions</b>   |
| <b>29</b>      | <b>.....Repairs</b>   |
| <b>29</b>      | <b>.....Service</b>   |
| <b>29</b>      | <b>.....Replacement Parts And Lamps</b>   |
| <b>29</b>      | <b>.....Eye Protection</b>  |
| <b>30</b>      | <b>.....Care And Cleaning</b>   |
| <b>31</b>      | <b>.....Relamping</b>   |
| <b>32 - 33</b> | <b>.....Facial Relamping</b>  |
| <b>34 - 41</b> | <b>.....Timer System</b>  |
| <b>42 - 54</b> | <b>.....154, 154/3, 144 and 144/3 Assembly Instructions</b>                             |
| <b>55 - 63</b> | <b>.....134, 134/3, 134VLR, 134/3VLR, 134C, 128 and 128/1<br/>Assembly Instructions</b> |
| <b>64 - 70</b> | <b>.....124 and 124/1 Assembly Instructions</b>   |
| <b>71</b>      | <b>.....Limited Warranty</b>  |

# SPECIFICATIONS

## 134

|                   |                                      |
|-------------------|--------------------------------------|
| LENGTH:           | 87.5"L X 42.5"w                      |
| WEIGHT:           | 720LBS                               |
| NUMBER OF LAMPS:  | 34                                   |
| ELECTRICAL DRAW:  | 23AMPS @ 220VOLTS*                   |
| CIRCUIT REQUIRED: | 220VOLTS, with ground, 30AMP Breaker |

## 134/3

|                   |                                      |
|-------------------|--------------------------------------|
| LENGTH:           | 87.5"L X 42.5"w                      |
| WEIGHT:           | 750LBS                               |
| NUMBER OF LAMPS:  | 34, 3 facial lamps                   |
| ELECTRICAL DRAW:  | 26AMPS @ 220VOLTS*                   |
| CIRCUIT REQUIRED: | 220VOLTS, with ground, 30AMP Breaker |

\*NOTE: Amperage will vary depending on voltage.

MELANIN - The brownish pigment produced by special cells in the base layer of the skin determines the individual's tan. As the skin is exposed to the ultraviolet light, the melanin is activated and combines with protein cells that rise to the skin's surface, thus producing a tan. The amount of melanin in your body determines how quickly and dark you tan. The more melanin produced and exposure time an individual has, the faster and deeper the individual will tan.

**NOTE:** The tan produced by the 134 is a deep, rich "COSMETIC" tan. However, regardless of how dark an individual may tan on this system, it will not provide adequate protections against overexposure to natural sunlight or UVB tanning systems.

- SKIN TYPE II - This is the individual that usually burns easily and severely, tans minimally or lightly and peels
- SKIN TYPE III - Often referred to as "AVERAGE" complexion. burns moderately and tans about average
- SKIN TYPE IV - This individual burns minimally, tans easily and above average with each exposure
- SKIN TYPE V - This individual rarely burns, tans easily and substantially

### IMPORTANT NOTE:

Customers that wear contact lenses, should be made aware that the heat and ventilation wind may dry out their contacts and should be removed prior to the session.

Use only creams, oils or lotions (particularly suntan lotions) that are recommended by Heartland Tanning, Inc. Equally important - many facial makeups have oil bases and sun block should be removed prior to a session.

It is recommended that following a tanning session, a skin moisturizer be applied. This promotes a smoother, more even looking tan.

# EXPOSURE SCHEDULE 134 and 134/3

**DANGER - ULTRAVIOLET RADIATION.** Follow instructions. Avoid overexposure. As with natural sunlight, overexposure can cause eye and skin injury and allergic reactions. Repeated exposure may cause premature aging of the skin and skin cancer. **Wear protective eyewear: failure to may result in severe burns or long-term injury to eyes.**

Medications or cosmetics may increase your sensitivity to the ultraviolet radiation. Consult physician before using sunlamp if you are using medications or have a history of skin problems or believe yourself especially sensitive to sunlight. If you do not tan in the sun, you are unlikely to tan from the use of this product.

This system is intended to be used only with Everglo 71"/100W lamps, Durasun F71BP 100W, Bellarium S SA1 71/100W and [Philips HPA 400/30 S lamps and Heraeus E-400 HPT lamps (facial unit, where applicable)].

## Questions on Sales or Service

Follow recommended exposure schedule for the skin type.

**Heartland Tanning, Inc. • Lee's Summit, MO • 1-800-554-8268**

| <b>RECOMMENDED EXPOSURE SCHEDULE</b>  |   |   |   |  |   |
|---|---|---|---|--|---|
| <b>Skin Type</b>  | <b>Week1<br/>1st - 3rd<br/>Treatments</b> | <b>Week2<br/>4th - 6th<br/>Treatments</b> | <b>Week 3<br/>7th - 10th<br/>Treatments</b> | <b>Week 4<br/>11th - 15th<br/>Treatments</b> | <b>Weekly<br/>Subsequent<br/>Treatments</b> |
| II - Fair   | 4MINUTES                                  | 8MINUTES                                  | 12MINUTES                                   | 16MINUTES                                    | 20MINUTES                                   |
| III - Average   | 4MINUTES                                  | 8MINUTES                                  | 12MINUTES                                   | 16MINUTES                                    | 20MINUTES                                   |
| IV - Brown  | 4MINUTES                                  | 12MINUTES                                 | 16MINUTES                                   | 20MINUTES                                    | 20MINUTES                                   |
| V - Dark Brown  | 4MINUTES                                  | 12MINUTES                                 | 16MINUTES                                   | 20MINUTES                                    | 20MINUTES                                   |
| <b>MAXIMUM EXPOSURE TIME IS 20 MINUTES</b>  |   |   |   |  |   |
| This product is in comformity with performace standards for sunlamp products under CFR 21 Part 1040 |   |   |   |  |   |

This unit utilized UVA lamps. **Replace only with Everglo 71"/100W lamps, Durasun F71 BP 100W, Bellarium S SA1 71/100W and [Philips HPA 400/30 S lamps and Heraeus E-400 HPT lamps (Facial unit, where applicable)].** The minimum exposure position is .5 inches (1.27 cm) from the lamps surface (preset by the mfg.). Read the instruction booklet before using this device. To use, lie down under canopy and pull down as far as adjustment will allow. **CAUTION: THE USE OF ANY OTHER POSITION MAY RESULT IN OVEREXPOSURE.**

Tanning can begin on a regular basis. An appearance of tanning normally appears after a few exposures and maximizes after four (4) weeks of exposure. **Use protective eyewear** whenever equipment is energized. Read the instruction booklet before using.

# WARNINGS AND CAUTIONS

Certain drugs - particularly those designed to produce photosensitivity - may cause individuals under the influence of this type drug to experience adverse effects and those people should avoid exposure to UV sources of all type. Doctors will advise persons taking these drugs of possible adverse effects.

It is recommended that only one (1) person at a time should use the tanning system, and advise using protective eyewear while using the tanning unit. Two (2) pair of protective eyewear are provided with each tanning bed sold.

## WARNING

If you have been diagnosed by physician as being allergic to the sun or are currently taking photosensitive medications, consult you physician before using the tanning unit.

## CAUTION

While there is no immediate clinical evidence regarding UVA exposure and its effects upon expectant mothers, it is strongly advised that expectant mothers be discouraged from using the tanning unit.

# MANDATORY READING

ALWAYS FOLLOW INSTRUCTIONS FOR PROPER USAGE PRIOR TO USING ANY TANNING SYSTEM

## REMEMBER

1. Follow the exposure schedule in accordance with you skin type. Failure to do so may result in overexposure.
2. Replacement lamps must comply with CFR 21 1040.20. When ordering lamps, include model number and serial number. See Lamp Guide on page 7 for the appropriate lamp replacements for your tanning bed.

Should you have any questions regarding the proper use of your tanning system, contact Heartland Tanning, Inc. at:

**1-800-554-8268**  
**8:00AM to 5:00PM (CST)**

# **REPAIRS - SERVICE - REPLACEMENT PARTS AND LAMPS - EYE PROTECTION**

If you are in need of any of the above mentioned products or services, you should contact the dealer/distributor through whom you purchased your unit. In the event that you are unable to do so, please call our Service Department for assistance at: 1-800-554-8268.

**NOTE:** All repairs and replacement components including, but not limited to, protective eyewear, lamps, timers and acrylic must be in compliance with CFR21 1040.20.

**NOTE: Electrical connection to power supply,  
must be in compliance with NECA  
regulations and performed by  
a qualified electrician.**

**Warning:  
Wear protective eyewear; failure to may result  
in severe burns or long-term injury to eyes.**



# **CARE AND CLEANING OF YOUR TANNING BED**

After each session is completed, spray acrylic with a specially formulated UVT (ultra-violet transmitting) acrylic cleaner. Wipe the acrylic with a clean cloth. The acrylic should never be wiped with a dry cloth because this will generate a slight static charge which will attract dust. A mild liquid detergent and water solution can be used temporarily in place of acrylic cleaner.

For maximum efficiency of your tanning bed, periodic cleaning of lamps is required. Refer to relamping instructions for acrylic removal.

**CAUTION:** Do not use excessive amounts of water, any abrasive cleaners, or any spray cleaner that carry label warnings regarding reactions to contact with skin!

## **DO NOT USE ALCOHOL**

**ELECTRICAL SAFETY:** The tanning unit should be disconnected from the power supply before cleaning or any repairs are made! Avoid water or solution entering the lamp compartment.

# **America's best tan™**

# RELAMPING INSTRUCTIONS

1. Disconnect power from unit.
2. Remove acrylic strips and slide acrylic out of the unit.
3. Turn the bi-pin lamp 90 degrees and remove from lampholder.
4. Align the bi-pin lamp and slide the top and bottom into the lampholder turn 90 degrees.
5. Clean and replace acrylic. (Refer: care and cleaning instructions.)
6. Reconnect unit to power.

## CAUTION

Replacement lamps must comply with CFR 21 1040.20  
When ordering lamps, include model number and serial number.

## LAMP GUIDE

### **\*154, 154/3 - 12<sup>MINUTE</sup>**

**Replace only with Cosmolux VHR 16180/160W lamps and Hi-Tan 10198/100W lamps, Philips HPA 400/30 S lamps and Heraeus E-400 HPT lamps (Facial unit, where applicable)**

### **\*154, 154/3 - 15<sup>MINUTE</sup>**

**Replace only with Cosmolux VHR 16180/160W lamps and Cosmolux VLR 16180/160W lamps, Philips HPA 400/30 S lamps and Heraeus E-400 HPT lamps (Facial unit, where applicable)**

### **\*144, 144/3**

**Replace only with Bellarium SR RA1-12/160W, Everglo 71"/100W lamps, Bellarium S SA1 71/100W or Durasun F71BP 100W, Philips HPA 400/30 S lamps and Heraeus E-400 HPT lamps (Facial unit, where applicable)**

### **134, 134/3**

**Replace only with Everglo 71"/100W, Durasun F71BP 100W, Bellarium S SA1 71/100W and [Philips HPA 400/30 S lamps and Heraeus E-400 HPT lamps (Facial unit, where applicable)].**

### **134 VLR, 134/3 VLR**

**Replace only with Cosmolux VLR 18810/100W lamps and Philips HPA 400/30 S lamps and Heraeus E-400 HPT lamps (Facial unit, where applicable)**

### **134C**

**Replace only with Cosmostar Longlife 12503/100W lamps**

### **128, 128/1**

**Replace only with Everglo 71"/100W, Durasun F71BP 100W, Bellarium S SA1 71/100W and [Everglo 59"/100W lamps, Philips HPA 400/30 S lamps and Heraeus E-400 HPT lamps (Facial unit, where applicable)].**

### **124, 124/1**

**Replace only with Everglo 71"/100W, Durasun F71BP 100W, Bellarium S SA1 71/100W and [Everglo 59"/100W lamps, Philips HPA 400/30 S lamps and Heraeus E-400 HPT lamps (Facial unit, where applicable)]**

\* Please note - when removing canopy acrylic from these units - requirement is 2 people, 1 person at each end of bed for ease of removal and installation.



# REPLACING 154/3, 144/3 AND 134/3 FACIAL LAMPS

1. DISCONNECT POWER FROM UNIT.
2. REMOVE (2) PHILLIPS PAN HEAD SCREWS (AT FRONT EDGE OF THE ACRYLIC) USING A #2 PHILLIPS SCREW DRIVER OR SCREW GUN.
3. PULL FRONT EDGE OF ACRYLIC/RAIL DOWN FROM CANOPY ALLOWING THE ACRYLIC TO HINGE DOWN FROM THE BACK SIDE.
4. REMOVE ACRYLIC FROM HINGE RAIL. EXPOSING FACIAL ASSEMBLY.
5. WHILE HOLDING FACIAL GLASS CASSETTE, REMOVE (4) RETAINING SCREWS USING A #2 PHILLIPS.

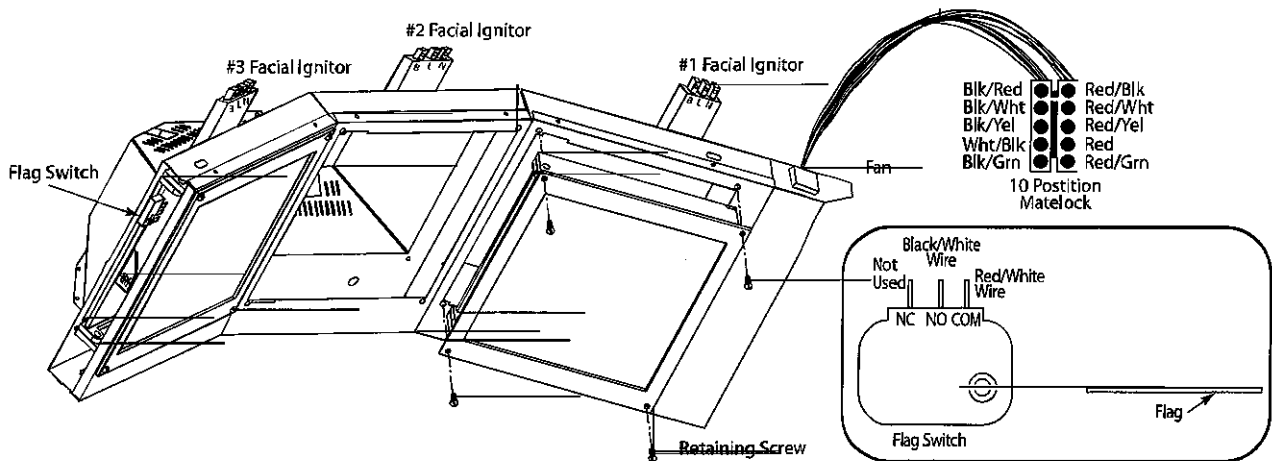

6. REMOVE FACIAL GLASS CASSETTE FROM FACIAL HOUSING EXPOSING 400 WATT FACIAL LAMP.
7. GRASP LAMP AT ONE END PRESSING TOWARDS THE OPPOSITE END TO RELEASE FROM LAMP BRACKET.
8. TO REPLACE 400 WATT FACIAL LAMP REVERSE PROCEDURES ABOVE. FOR MULTIPLE FACIALS, DUPLICATE STEPS ABOVE FOR EACH SINGULAR LAMP BEING REPLACED.

**NOTE: ONLY GRASP 400 WATT FACIAL LAMP FROM EITHER END; ALWAYS USE ALCOHOL TOWEL PROVIDED WITH LAMP TO WIPE OFF LAMP AFTER INSTALLATION.**

**CAUTION: DO NOT CHECK FACIAL LAMP OPERATION WITH FACIAL GLASS CASSETTE REMOVED.**

**\*ALWAYS WEAR UV PROTECTIVE EYEWEAR WHEN REPLACING LAMPS AND CHECKING OPERATION.**

# USE AND GUIDE TO TIMER SYSTEM

(C) COPYRIGHT 1999 by Salon Systems, Inc.

The information in this manual is believed to be correct. However, Salon Systems, Inc. assumes no responsibility for any errors herein.

This information is subject to change without notice, and should not be construed as a commitment by Salon Systems, Inc.

A factory 3 second delay between all functions is standard on all Ovation™ beds.

## TIMER WARRANTY

This product is warranted against defective materials and workmanship for a period of one year from date of purchase. In the event the product fails to perform, it may be returned; Shipping Paid, to the factory to be serviced or replaced at the factory's discretion. Salon System, Inc. will pay to ship the repaired or replaced product by the shipping means of our choosing. Returns will not be accepted without a Return Authorization Number assigned by the factory. It is a Condition of Sale that the user of Salon Systems, Inc.'s products assumes all risk and responsibility of use and indemnifies Salon Systems, Inc. against all damages. Salon Systems Inc. is not liable for loss of profits, loss savings, special, incidental, consequential, indirect or other similar damages arising from breach of warranty, breach of contract, negligence, or other legal action even if Salon Systems, Inc. or its agent has been advised of the possibility of such damages, or for any claim brought against you by another party. This warranty allocates risks of product failure between the Purchaser and Salon Systems, Inc. Salon Systems, Inc.'s hardware pricing reflects this allocation of risk and the limitations of liability contained in this warranty. It is a violation of the stated warranty to cut or modify the provided modular cables supplied with the T-Max Series Timers. Connection the T-Max Series to third party timers not approved by Salon Systems, Inc. also violates the stated warranty. Contact your dealer or Salon Systems, Inc. if you are not sure if the timer that you are connection is an approved timer.

## *T-Max/004 OEM Installation and User's Guide*

### OVERVIEW

Congratulations on your purchase of Salon Systems, Inc.'s T-Max Series of tanning bed timers. The T-Max Series is designed for complete automation and control of your tanning equipment.

A Heartland Timer is an OEM board that can be installed in a tanning bed or tanning booth. Each Heartland Timer can individually control a tanning bed, can be connected back-to-back with a T-Max 1A or T-Max 3A for remote front desk control or be connected with many Heartland Timers and a T-Max Manager or Manager/Plus to control many beds from a remote location. Operation is accomplished via front panel controls. This manual should be used by the licensed electrician installing your T-Max timing system. Check for compliance with local building codes.

### CONFIGURATION

#### Setting Parameters

**Note:** If you are using a T-Max Manager or T-Max Manager/Plus and multiple Heartland Timers, remove power from the T-Max Manager or T-Max Manager/Plus and keep the power removed until all parameter changes are complete.

1. Press and hold the Start/Stop and the Up buttons simultaneously on the Heartland Timer. As soon as you see a ".1" on the display release the buttons. This should take about 5-6 seconds. This is an indication that you are in the parameter mode. The numbers currently displayed represents the parameter number that you can observe or change.
2. Press the Up and Down buttons until the parameter number that you want to observe or change is displayed.

3. Press the Start/Stop button. The current value for that parameter will be displayed and flashing.

The Heartland Timer will show a number with a period illuminated in the lower center of the display. The number shown is the current value for that parameter.

For Lamp, Session Counts, etc. the value displayed can be as high as 9999. To display this value, the Heartland Timer will flash tow numbers-three times, then two numbers-three times, pause, two numbers-three times, two numbers-three times, pause, etc. For example, if you are checking lamp hours (Parameter 6) and the display flashes the numbers 53 three times, then 14 three times, pauses then repeats, then the total lamp hours stored in that Heartland Timer is 5314.

4. Press the Up and Down buttons to change the parameter to the desired value.  
If you want to clear the value for that parameter, press the Up and Down buttons at the same time until the display shows 0.0.
5. Press the Start/Stop button.  
The display will show the parameter number you just change and a solid period in the lower center of the display. You may now change another parameter by pressing the Up and Down buttons until the parameter that you want to change is displayed. Repeat Steps 2-4 for each parameter you want to change.
6. To exit the Parameter mode and make the Heartland Timer available for the next session, press and hold the both Up and Down buttons until the display shows a 0 with no periods displayed.

# Setting The Address

Note: If you are using the Heartland Timer as an independent timer, you don't need to set the address on the Heartland Timer.

1. Press and hold the Start/Stop buttons simultaneously on the Heartland Timer until a .1 appears on the display. Release the buttons. This should take about 5-6 seconds.
2. Press and release the Start/Stop button. A number will appear on the display and be flashing. A period will be illuminated in the center of the display. Pressing and holding the Up button will cause the display to count up. Once the count reaches 100, the center period will flash rapidly. This is an indication that you are over 99. For example, if the display shows a 0.2 with the period flashing, this is address 102. The highest the display will count up is 254.
3. Press the Up and Down buttons until the desired address is displayed. When setting the address, remember 3 rules:
  - A) Set each Heartland Timer to a unique address. B) Do not set any address to 0.
  - C) Do not set any address over 100.
4. Press the Start/Stop button. The ".1" will appear on the display. The 1 will not be flashing.
5. To exit, press and hold both Up and Down buttons until the display shows a 0 with no periods displayed.

Table 1 - Parameter numbers for observing and changing parameters.

| Param.#     | Description           | Max # | Default | Notes   |
|-------------|-----------------------|-------|---------|---|
| Salon Level |                       |       |         |   |
| 1           | Address               | 128   | 1       | Set this number to the room number you want the timer to be   |
| 2           | Beep Mode             | 1     | 0       | Used for High Power beds. 0=Alarm Only, 1=Alarm and Flip  |
| 3           | Delay Time            | 10    | 3       | Delay in minutes stored in the Heartland Timer  |
| 5           | Session               | 65535 | 0       | Total Session counts for Heartland Timer Counts   |
| 6           | Lamp Hours            | 65535 | 0       | Bulb hours for each bed   |
| 7           | Bed Hours             | 65535 | 0       | How may hours a bed is on   |
| 8           | Manual Session Counts | 65535 | 0       | Counts the # of sessions the Heartland Timer Session has run while in Stand Alone Mode  |
| 9           | Clean Room            | 1     | 1       | 0 = Clean Room Disabled, 1 = Enabled  |
| 10          | Manual Lockout*       | 1     | 0       | 0 = Stand Alone Enabled, 1 = Disabled   |
| 13          | Cool Down Mode        | 10    | 3       | 0 = Disabled, 1-10 = Enabled. Time delay in minutes allowing bed to cool. The fans will remain running while the Heartland Timer is in cool down mode.  |
| 14          | 5 Min. Beep           | 1     | 0       | 0 = Disabled, 1 = Enabled. Heartland Timer will beep for 10 seconds every 5 minutes   |
| 15          | Fixed Session         | 65535 | 0       | Counts number of sessions ran through the TMax® 3A. This value cannot be changed at all. Used as point of reference.  |
| 16          | Pulse Mode            | 1     | 0       | 0 = Disabled, 1 = Enabled. When session starts, the relay on the T-Max® 1A will close for 1-2 seconds then open.  |
| 17          | Clean Clear           | 1     | 0       | 0 = Press and hold the Set button for 3-4 seconds to clear the clean room. 1 = Press and release the Set button to instantly clear the clean room.  |
| 18          | Redisplay             | 2     | 0       | 0 = After a session ends and the clean room is cleared, the Heartland Timer will show a 0. 1 = After session ends and the clean room is cleared, the Heartland Timer will show the last session time entered. 2 = After the session ends and the clean room is cleared, the max. time will show on the Heartland Timer. |
| 19*         | Third Part Interface  | 1     | 0       | When set to a 1, voltage must be applied by an outside source to the TPI input on the back of the Heartland Timer. Used is the timer is being controlled by either a FST® or Database® Series Timer. See Section for JPI settings   |

## Setting Delay Time

If the Heartland Timer is being controlled by a T-Max 1A, T-Max 3A, T-Max Manager or T-Max Manager/Plus, the delay does not need to be set on the Heartland Timer. The delay is controlled by the controlling device.

1. Press and hold the Start/Stop and Up buttons simultaneously the Heartland Timer until a ".1" appears on the display. Release the buttons. This should take about 5-6 seconds.
2. Press the Up and Down button until a ".3" is displayed.
3. Press and release the Start/Stop button. A number will appear on the display and be flashing. A period will be illuminated in the center of the display. This is the current delay time.
4. Press the Up and Down button until the desired delay time is displayed. The highest delay time that can be set on the Heartland Timer is 10 minutes. If you want no delay time, set the display to 0. If you set the delay time to 0, the session time will start immediately after the Start/Stop button is pressed.
5. Press the Start/Stop button. The ".3" will appear on the display. The 3 will not be flashing.
6. To exit, press and hold both the Up and Down buttons until the display shows a "0" with no periods displayed.

## IN-ROOM SINGLE BED CONTROL

### Starting A Session

1. Press the Up and Down button on the Heartland Timer until the desired session time is displayed. If the display shows a 0, and you want to count down from the maximum time, press the down button.
2. Press and release the Start/Stop button to start the session. If a delay other than 0 is entered, the delay will count down. A period on the lower right corner of the display will flash rapidly. When the session starts, the period will flash at a once per second rate. If the delay is set to 0, the session will start immediately.

### Pausing A Session

To pause the session press the Start/Stop button. The flashing period on the lower right corner of the display will stop flashing and stay illuminated. To restart, press the Start/Stop button on the Heartland Timer. The period on the lower right corner of the display will resume flashing.

**NOTE:** The session time will continue to count down. The display will continue to update and reflect the remaining session time.

### Canceling A Session

To cancel a session, press the Start/Stop button to pause the session then press the Up button. The display will show a solitary 0.

## REMOTE SINGLE BED CONTROL

Remote Single Bed Control is the ability to control a single tanning bed from a remote location. T-Max 3A at the remote location is required for this configuration.

## Wiring

Wire the Heartland Timer to the tanning bed. Apply power to the T-Max 3A as described in their respective User's Guides.

Run the provided modular cable from the tanning room to the remote T-Max 3A or T-Max 1A. Connect the modular cable to one of the RJ-22 ports on the Heartland Timer and T-Max 1A or T-Max 3A (see RJ-22 ports for T-Max Series timers on page 16, figure B).

## Configuration

Set the address on the Heartland Timer in the tanning room to 1. Set the address on the T-Max 3A to 0.0. For setting the delay refer to the T-Max 3A user's guide.

**Note:** When setting the address on the Heartland Timer in the tanning room, the power to the front desk T-Max 1A or 3A must be off.

## Session Control

Starting a session

1. Press the Up and Down button on the T-Max 3A or the Set button on the T-Max 1A at the front desk until the session time is displayed. Time cannot be set from the Heartland Timer in the room.
2. Press the Start/Stop button on the front desk T-Max 1A or T-Max 3A to start the session.

If a delay other than 0 is set, the delay will count down. A period on the lower right corner of the display will flash rapidly. When the session starts, the period will flash at once per second rate. If a 0 delay is entered, the session will start immediately.

## Pause during the Session

To pause the session press the Start/Stop button on the Heartland Timer in the tanning room. The flashing period on the lower right corner of the display will stop flashing and stay illuminated. To restart the session, press the Start/Stop button on the Heartland Timer in the tanning room. The period will continue flashing.

**Note:** The session time will continue to count down. The display will continue to update and reflect the remaining session time.

## Canceling a session

To cancel a session, press both the Start/Stop and Up button on the T-Max 3A at the front desk simultaneously. If you are using a T-Max 1A, press the Start/Stop and the Set buttons simultaneously. The session cannot be canceled from the Heartland Timer.

## USING THE HEARTLAND TIMER WITH A T-MAX MANAGER OR T-MAX MANAGER/PLUS/PRO

If you are using Heartland Timers with a T-Max Manager or T-Max Manager/Plus, follow these instructions for proper operation:

1. Set the address on each Heartland Timer.

**Note:** If this is a first time installation, go through the quick installation procedure in Section 2 of the T-Max Manager or T-Max Manager/Plus user's guides. This will automatically set the address on the Heartland Timers and you will not need to set the addresses manually as described in the following steps. If you need to set the address on the Heartland Timer manually, be sure to set each Heartland Timer to a different address. No Heartland Timer should be set to address 00.

2. Connect each Heartland Timer together using a modular cable that conforms to the pinouts shown on Figure B. Connect T-Max Manager or T-Max Manager/Plus to the closest Heartland Timer in the line (refer to Figure C).

**Note:** Delay is controlled by the T-Max Manager, the T-Max Manager/Plus or the software you are using if you are using a computer. It is not necessary to set the delay on the Heartland Timer. Refer to the T-Max Manager or T-Max Manager/Plus User's Guide for operation.

## OTHER FEATURES

### Clean Room

Once a session time has elapsed, the display will show two solid periods only. This is an indication that the room needs to be cleaned. To clear the clean room indication, press and hold the Up button on the Heartland Timer in the tanning room until the two period disappear and a "0" appears. To disable the clean room feature, set parameter 9 to a 0.

### Lamp Hours

To check and change Lamp Hours (or any other parameter).

### TPI ( Third Party Input) Mode

If you are using a FST or Database Series timers, you will need to place the Heartland Timer in the TPI mode.

### Connecting the TPI Input

1. Set Parameter 19 to a 1.
2. Connect the two actuator wires from the FST or Database timer to the TPI input in the back of the Heartland timer. When a session is started the FST timer will place 5v on these two wires. If you are using a database Series timer, 24 volts will be applied.

### Connecting the TPI output

#### FST:

1. There are three wires coming from the FST series timer. Two are the actuator wires connected to the signal input. Connect the third wire to one of the switch terminals. Make sure J6 and J7 are on and J4 and J5 are off.
2. Run a jumper from the black actuator wire connected to the other switch screw terminal.

#### Database:

There are four wires coming from the database series timer. Two are the actuator wires connected to the signal input. Connect the two other wires to the TPI relay output terminal J1. Make sure J6, J4 and J5 are off and J7 is on. Contact closure

If your external timer is simply a relay contact closure, make sure J4, J6, and J5 are on and J7 is off.

Important: J4, J5, and J7 should never be on at the same time!!!

### Operation

When a session is started, voltage will be applied to the TPI input. The display on the Heartland Timer will show the maximum time and count down. When the session ends, the voltage will be removed from the TPI input and the bed will turn off. Any remaining session time showing on the Heartland Timer will be eclipsed.

**Note:** The Heartland timer can not be used as a stand alone time in the TPI mode.

If the FST or Database Series timers are in delay the Heartland Timer will show a 0. However, pressing the Start/Stop button on the Heartland Timer will eclipse the delay time and start the session. Pressing the Start/Stop button on the Heartland timer will also clear the clean room indication on the FST and Database timers.

## Cool down mode

Cool down mode is the time the bed needs to cool down after a session has ended. The Factory default setting is 3 minutes.

1. Connect the wires that control the fans to the headers on the back of the Heartland timer.

2. Set parameter 13 to the desired cool down time.

After a session has ended the display will show a single period in the middle of the display. The period will remain until the cool down time has elapsed. The display will then show a 0.

**Note:** If both cool down time and clean room are enabled, the clean room will be displayed. If the clean room indication is cleared before the cool down time has expired, the cool down indication will be displayed. If the cool down time has elapsed before the clean room indication has been cleared, the clean room indication will remain until it is cleared.

**Figure A - Front View Of The Heartland Timer**  
Display Board Front View

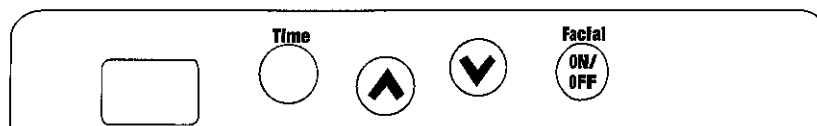

12' modular cable to power board

**Note:** D6 - Run and communications indication lights. Will flash at a once per second rate when operating a stand alone mode. When flashing rapidly the communications are active (either with a T-Max® Manager or Master T-Max® 3A). Will stay on solid if timer is in TPI mode.

D5 - Power indication.

**Figure B - Power Board Location**

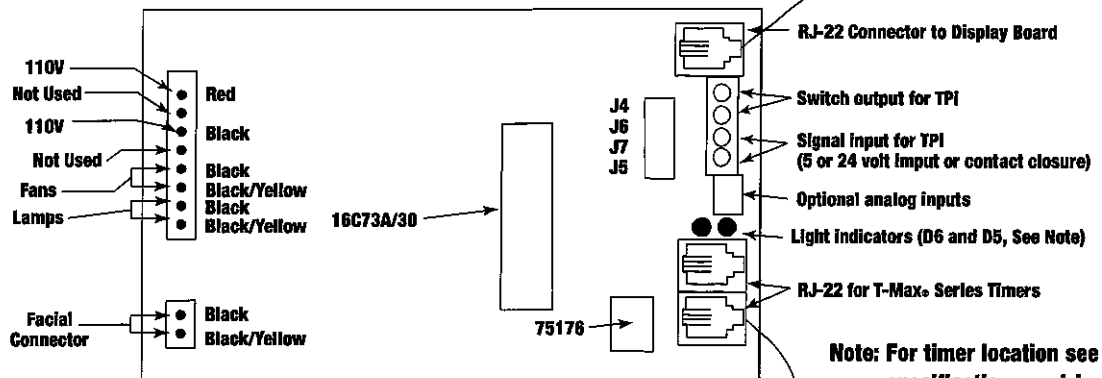

**Note:** For timer location see specifications - wiring diagram ballast box for your model.

T-Max Remote  
or T-Max Manager/  
Plus/Pro

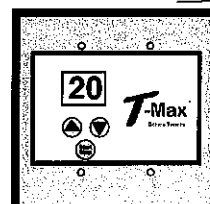



**134, 134/3, 134 VLR, 134/3 VLR, 134C  
128 and 128/1  
Bed Assembly  
and Wiring Diagrams**

# 134, 134/3, 134 VLR, 134/3 VLR 134C, 128 and 128/1 ASSEMBLY INSTRUCTIONS

## TOOLS YOU WILL NEED:

- A. 9/16" SOCKET
- B. 7/16" SOCKET
- C. 1/4" ALLEN WRENCH (PROVIDED)
- D. 5/32" ALLEN WRENCH (PROVIDED)
- E. 13mm SOCKET OR ADJUSTABLE CRESCENT WRENCH
- F. TWO (2) OR MORE PEOPLE

STEP 1: POSITION THE BENCH UPSIDE DOWN. DETERMINE LEFT AND RIGHT LEGS BY POSITIONING THE SHOULDER BOLTS ON THE LEGS TO THE INSIDE AND FRONT OF THE UNIT. USING THE 1/4" - 20 X 7/8 BOLTS AND 1/4" WASHERS PROVIDED AND BOLT THE LEGS TO THE BENCH. (USING THE 7/16 SOCKET WRENCH).

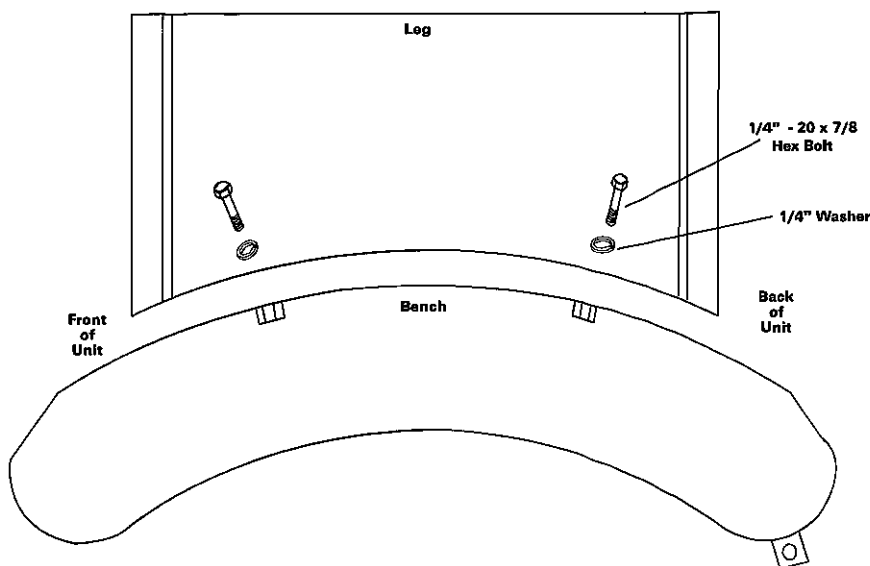

STEP 2: TURN THE UNIT RIGHT SIDE UP, PLACE THE CANOPY ON THE TOP OF THE BENCH ALIGNING THE HINGE PLATES, BOLT THE HINGE PLATES TOGETHER (USING THE 1/2" X 1 1/4" SHOULDER BOLT, 3/8" NUT, 9/16" SOCKET AND THE 1/4" ALLEN WRENCH).

STEP 3: ALIGN HOLES IN BRAKE WITH HOLES IN THE HINGE BRACKET, BOLT TOGETHER WITH 10-24 X 1" SOCKET HEAD AND 5/32" ALLEN WRENCH.

STEP 4: USING 5/32" ALLEN WRENCH PROVIDED TIGHTEN THE BRAKE ADJUSTMENT SCREW UNTIL SNUG. **(DO NOT OVERTIGHTEN)**

STEP 5: REMOVE NUT FROM EACH END OF THE SHOCK. ATTACH PAINTED END OF SHOCK TO CANOPY, ATTACH SILVER END TO BENCH. TIGHTEN NUTS ON EACH END OF SHOCK. THE SILVER PART OF SHOCK ATTACHES TO CENTER POSITION ON BENCH. **(FOR PROPER CANOPY ADJUSTMENT, SEE NOTE BELOW).**

**NOTE: PROPER CANOPY ADJUSTMENT** - IF CANOPY RAISES ON IT'S OWN, MOVE SHOCK ADJUSTMENT ON BENCH TO REAR POSITION. IF CANOPY FALLS TO QUICKLY, MOVE SHOCK ADJUSTMENT ON BENCH TO FORWARD POSITION.

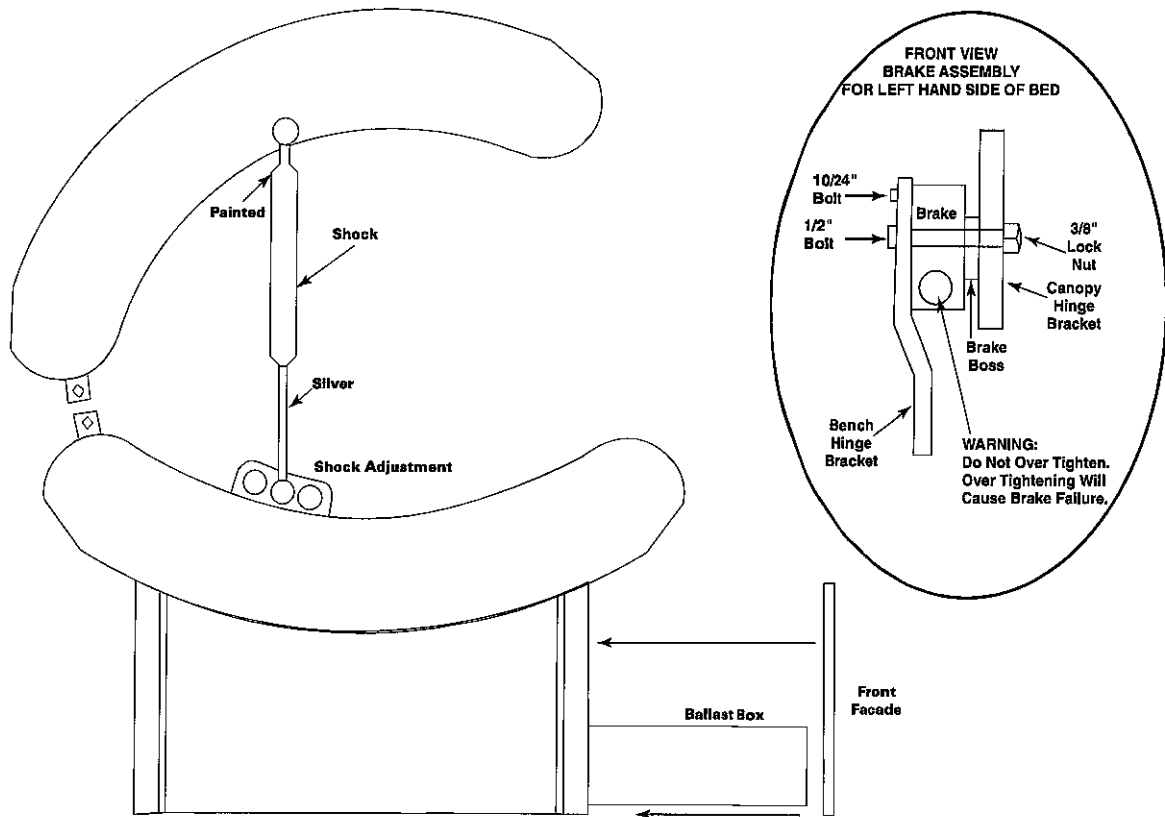

STEP 6: REMOVE COVER ON BALLAST TRAY. LOCATE BLACK TIMER WIRE FROM BOTTOM OF BENCH. PLUG IN BLACK TIMER WIRE TO TIMER BOARD INSIDE BALLAST TRAY. REINSTALL COVER ON BALLAST TRAY. (SEE TIMER SECTION FOR DETAILS).

STEP 7: PLACE THE BALLAST BOX BETWEEN THE LEGS OF THE UNIT. RUN CORDS 1 AND 2 FROM THE BENCH TO THE BALLAST BOX, RUN CORDS 3 AND 4 FROM THE CANOPY TO THE BALLAST BOX. PLACE THE FRONT FACADE ONTO THE FRONT OF THE UNIT.

**WARNING: TO INSURE PROPER INSTALLATION OF CORDS, TIGHTEN CORDS UNTIL THEY LOCK.**

**NOTE:** WEAR PROTECTIVE EYEWEAR; FAILURE TO DO SO MAY RESULT IN SEVERE BURNS OR LONG-TERM INJURY TO EYES.

**NOTE:** ELECTRICAL CONNECTION TO POWER SUPPLY MUST BE IN COMPLIANCE WITH NECA REGULATIONS AND PERFORMED BY A QUALIFIED ELECTRICIAN.

**IF YOU HAVE ANY QUESTIONS, PLEASE CALL: 1-800-554-8268**

# 134 SERIES AND 128 SERIES

## HARNESS CORD #1 / RECEPTACLE #1

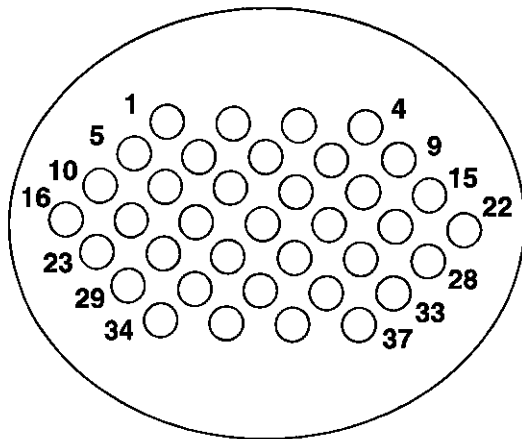

| PIN# | COLOR       | RECEPTACLE LOCATION | PLUG LOCATION      |
|------|-------------|---------------------|--------------------|
| 1    | Blue        | Lamp 1 head end     | Ballast 1-1        |
| 2    | Yellow      | Lamp 2 head end     | Ballast 1-2        |
| 3    | Orange      | Lamp 3 head end     | Ballast 1-3        |
| 4    | Purple      | Lamp 4 head end     | Ballast 1-4        |
| 5    | Grey        | Lamp 5 head end     | Ballast 1-5        |
| 6    | Pink        | Lamp 6 head end     | Ballast 1-6        |
| 7    | Tan         | Lamp 7 head end     | Ballast 1-7        |
| 8    | Light Blue  | Lamp 8 head end     | Ballast 1-8        |
| 9    | Empty       |                     |                    |
| 10   | Empty       |                     |                    |
| 11   | Empty       |                     |                    |
| 12   | Empty       |                     |                    |
| 13   | Empty       |                     |                    |
| 14   | Red         | Fan Circuit         | Fan Terminal Strip |
| 15   | Empty       |                     |                    |
| 16   | White/Red   | Fan Circuit         | Fan Terminal Strip |
| 17   | Empty       |                     |                    |
| 18   | Empty       |                     |                    |
| 19   | Green       | Ground              | Ground             |
| 20   | Empty       |                     |                    |
| 21   | Empty       |                     |                    |
| 22   | Black       | Fan Circuit         | Fan Terminal Strip |
| 23   | Empty       |                     |                    |
| 24   | White/Black | Fan Circuit         | Fan Terminal Strip |
| 25   | Empty       |                     |                    |
| 26   | Empty       |                     |                    |
| 27   | Empty       |                     |                    |
| 28   | Empty       |                     |                    |
| 29   | Empty       |                     |                    |
| 30   | Blue        | Lamp 1 foot end     | Capacitor 1-1      |
| 31   | Yellow      | Lamp 2 foot end     | Capacitor 1-2      |
| 32   | Orange      | Lamp 3 foot end     | Capacitor 1-3      |
| 33   | Purple      | Lamp 4 foot end     | Capacitor 1-4      |
| 34   | Grey        | Lamp 5 foot end     | Capacitor 1-5      |
| 35   | Pink        | Lamp 6 foot end     | Capacitor 1-6      |
| 36   | Tan         | Lamp 7 foot end     | Capacitor 1-7      |
| 37   | Light Blue  | Lamp 8 foot end     | Capacitor 1-8      |

Lamp orientation is from FRONT of unit to BACK of unit (#1 through #16)

## HARNESS CORD #2 / RECEPTACLE #2

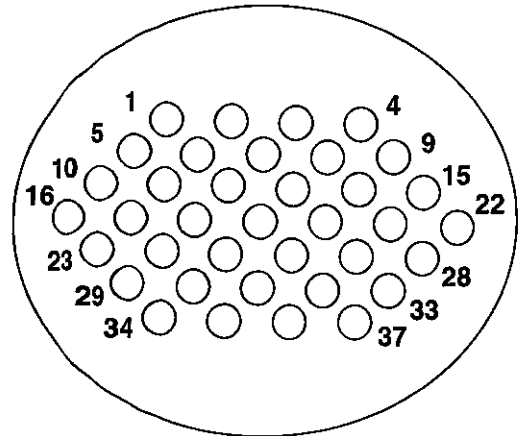

| PIN# | COLOR      | RECEPTACLE LOCATION | PLUG LOCATION      |
|------|------------|---------------------|--------------------|
| 1    | Blue       | Lamp 9 head end     | Ballast 2-1        |
| 2    | Yellow     | Lamp 10 head end    | Ballast 2-2        |
| 3    | Orange     | Lamp 11 head end    | Ballast 2-3        |
| 4    | Purple     | Lamp 12 head end    | Ballast 2-4        |
| 5    | Grey       | Lamp 13 head end    | Ballast 2-5        |
| 6    | Pink       | Lamp 14 head end    | Ballast 2-6        |
| 7    | Tan        | Lamp 15 head end    | Ballast 2-7        |
| 8    | Light Blue | Lamp 16 head end    | Ballast 2-8        |
| 9    | Empty      |                     |                    |
| 10   | Empty      |                     |                    |
| 11   | Empty      |                     |                    |
| 12   | Empty      |                     |                    |
| 13   | Empty      |                     |                    |
| 14   | Empty      |                     |                    |
| 15   | Empty      |                     |                    |
| 16   | White/Red  | Fan Circuit         | Fan Terminal Strip |
| 17   | Empty      |                     |                    |
| 18   | Empty      |                     |                    |
| 19   | Green      | Ground              | Ground             |
| 20   | Empty      |                     |                    |
| 21   | Empty      |                     |                    |
| 22   | Black      | Fan Circuit         | Fan Terminal Strip |
| 23   | Empty      |                     |                    |
| 24   | Empty      |                     |                    |
| 25   | Empty      |                     |                    |
| 26   | Empty      |                     |                    |
| 27   | Empty      |                     |                    |
| 28   | Empty      |                     |                    |
| 29   | Empty      |                     |                    |
| 30   | Blue       | Lamp 9 foot end     | Capacitor 2-1      |
| 31   | Yellow     | Lamp 10 foot end    | Capacitor 2-2      |
| 32   | Orange     | Lamp 11 foot end    | Capacitor 2-3      |
| 33   | Purple     | Lamp 12 foot end    | Capacitor 2-4      |
| 34   | Grey       | Lamp 13 foot end    | Capacitor 2-5      |
| 35   | Pink       | Lamp 14 foot end    | Capacitor 2-6      |
| 36   | Tan        | Lamp 15 foot end    | Capacitor 2-7      |
| 37   | Light Blue | Lamp 16 foot end    | Capacitor 2-8      |

Lamp orientation is from FRONT of unit to BACK of unit (#1 through #16)

# 134 SERIES AND 128 SERIES

## HARNESS CORD #3 / RECEPTACLE #3

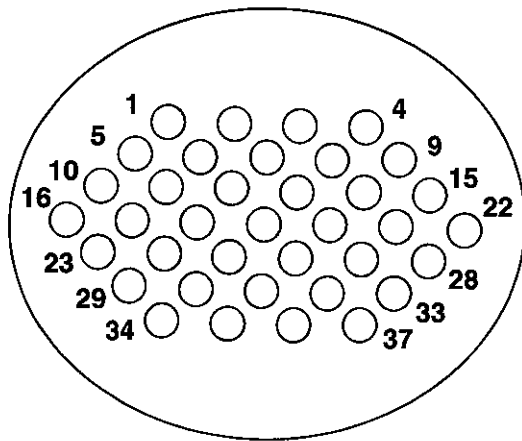

| PIN# | COLOR         | RECEPTACLE LOCATION       | PLUG LOCATION         |
|------|---------------|---------------------------|-----------------------|
| 1    | Blue          | Lamp 1 head end           | Ballast 3-1           |
| 2    | Yellow        | Lamp 2 head end           | Ballast 3-2           |
| 3    | Orange        | Lamp 3 head end           | Ballast 3-3           |
| 4    | Purple        | Lamp 4 head end           | Ballast 3-4           |
| 5    | Grey          | Lamp 5 head end           | Ballast 3-5           |
| 6    | Pink          | Lamp 6 head end           | Ballast 3-6           |
| 7    | Tan           | Lamp 7 head end           | Ballast 3-7           |
| 8    | Light Blue    | Lamp 8 head end           | Ballast 3-8           |
| 9    | White/Orange  | Lamp 9 head end           | Ballast 3-9           |
| 10   | Red/Black*    | Facial Ballast #1         | Facial Ignitor #1     |
| 11   | Empty         |                           |                       |
| 12   | Red/Yellow*   | Facial Ballast #2         | Facial Ignitor #2     |
| 13   | Empty         |                           |                       |
| 14   | Red           | Facial Fan                | Facial Terminal Strip |
| 15   | Red/Green*    | Facial Ballast #3         | Facial Ignitor #3     |
| 16   | White/Red     | Fan Circuit Ballast       | Fan Terminal Strip    |
| 17   | Empty         |                           |                       |
| 18   | Red/White     | Contactors Facial Control | Common on Flag Switch |
| 19   | Green         | Ground                    | Ground                |
| 20   | Black/White   | Facial Timer Switch       | Open Flag Switch      |
| 21   | Empty         |                           |                       |
| 22   | Black         | Fan Circuit               | Fan Terminal Strip    |
| 23   | Black/Red*    | Facial Terminal Strip     | Facial Ignitor #1     |
| 24   | White/Black   | Fan Circuit               | Contactors-Fan        |
| 25   | Black/Yellow* | Facial Terminal Strip     | Facial Ignitor #2     |
| 26   | Empty         |                           |                       |
| 27   | Black/Green*  | Facial Terminal Strip     | Facial Ignitor #3     |
| 28   | Empty         |                           |                       |
| 29   | Blue          | Lamp 1 foot end           | Capacitor 3-1         |
| 30   | Yellow        | Lamp 2 foot end           | Capacitor 3-2         |
| 31   | Orange        | Lamp 3 foot end           | Capacitor 3-3         |
| 32   | Purple        | Lamp 4 foot end           | Capacitor 3-4         |
| 33   | Grey          | Lamp 5 foot end           | Capacitor 3-5         |
| 34   | Pink          | Lamp 6 foot end           | Capacitor 3-6         |
| 35   | Tan           | Lamp 7 foot end           | Capacitor 3-7         |
| 36   | Light Blue    | Lamp 8 foot end           | Capacitor 3-8         |
| 37   | White/Orange  | Lamp 9 foot end           | Capacitor 3-9         |

\*If unit is equipped with Facial Cassettes  
Lamp orientation is from FRONT of unit to BACK of unit (#1 through #18)

## HARNESS CORD #4 / RECEPTACLE #4

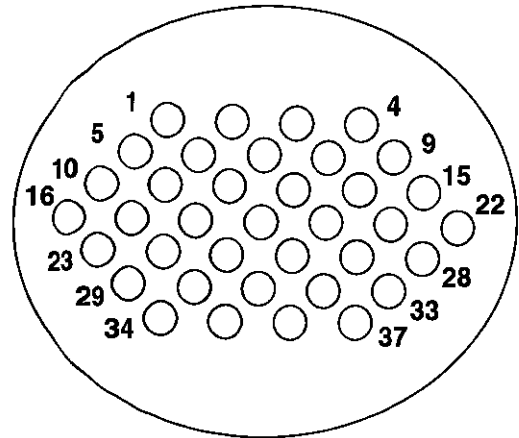

| PIN# | COLOR        | RECEPTACLE LOCATION | PLUG LOCATION      |
|------|--------------|---------------------|--------------------|
| 1    | Blue         | Lamp 10 head end    | Ballast 4-1        |
| 2    | Yellow       | Lamp 11 head end    | Ballast 4-2        |
| 3    | Orange       | Lamp 12 head end    | Ballast 4-3        |
| 4    | Purple       | Lamp 13 head end    | Ballast 4-4        |
| 5    | Grey         | Lamp 14 head end    | Ballast 4-5        |
| 6    | Pink         | Lamp 15 head end    | Ballast 4-6        |
| 7    | Tan          | Lamp 16 head end    | Ballast 4-7        |
| 8    | Light Blue   | Lamp 17 head end    | Ballast 4-8        |
| 9    | White/Orange | Lamp 18 head end    | Ballast 4-9        |
| 10   | Empty        |                     |                    |
| 11   | Empty        |                     |                    |
| 12   | Empty        |                     |                    |
| 13   | Empty        |                     |                    |
| 14   | Empty        |                     |                    |
| 15   | Empty        |                     |                    |
| 16   | White/Red    | Fan Circuit         | Fan Terminal Strip |
| 17   | Empty        |                     |                    |
| 18   | Empty        |                     |                    |
| 19   | Green        | Ground              | Ground             |
| 20   | Empty        |                     |                    |
| 21   | Empty        |                     |                    |
| 22   | Black        | Fan Circuit         | Fan Terminal Strip |
| 23   | Empty        |                     |                    |
| 24   | Empty        |                     |                    |
| 25   | Empty        |                     |                    |
| 26   | Empty        |                     |                    |
| 27   | Empty        |                     |                    |
| 28   | Empty        |                     |                    |
| 29   | Blue         | Lamp 10 foot end    | Capacitor 4-1      |
| 30   | Yellow       | Lamp 11 foot end    | Capacitor 4-2      |
| 31   | Orange       | Lamp 12 foot end    | Capacitor 4-3      |
| 32   | Purple       | Lamp 13 foot end    | Capacitor 4-4      |
| 33   | Grey         | Lamp 14 foot end    | Capacitor 4-5      |
| 34   | Pink         | Lamp 15 foot end    | Capacitor 4-6      |
| 35   | Tan          | Lamp 16 foot end    | Capacitor 4-7      |
| 36   | Light Blue   | Lamp 17 foot end    | Capacitor 4-8      |
| 37   | White/Orange | Lamp 18 foot end    | Capacitor 4-9      |

\*If unit is equipped with Facial Cassettes  
Lamp orientation is from FRONT of unit to BACK of unit (#1 through #18)

# 134 & 128 SERIES WIRING DIAGRAM BALLAST BOX

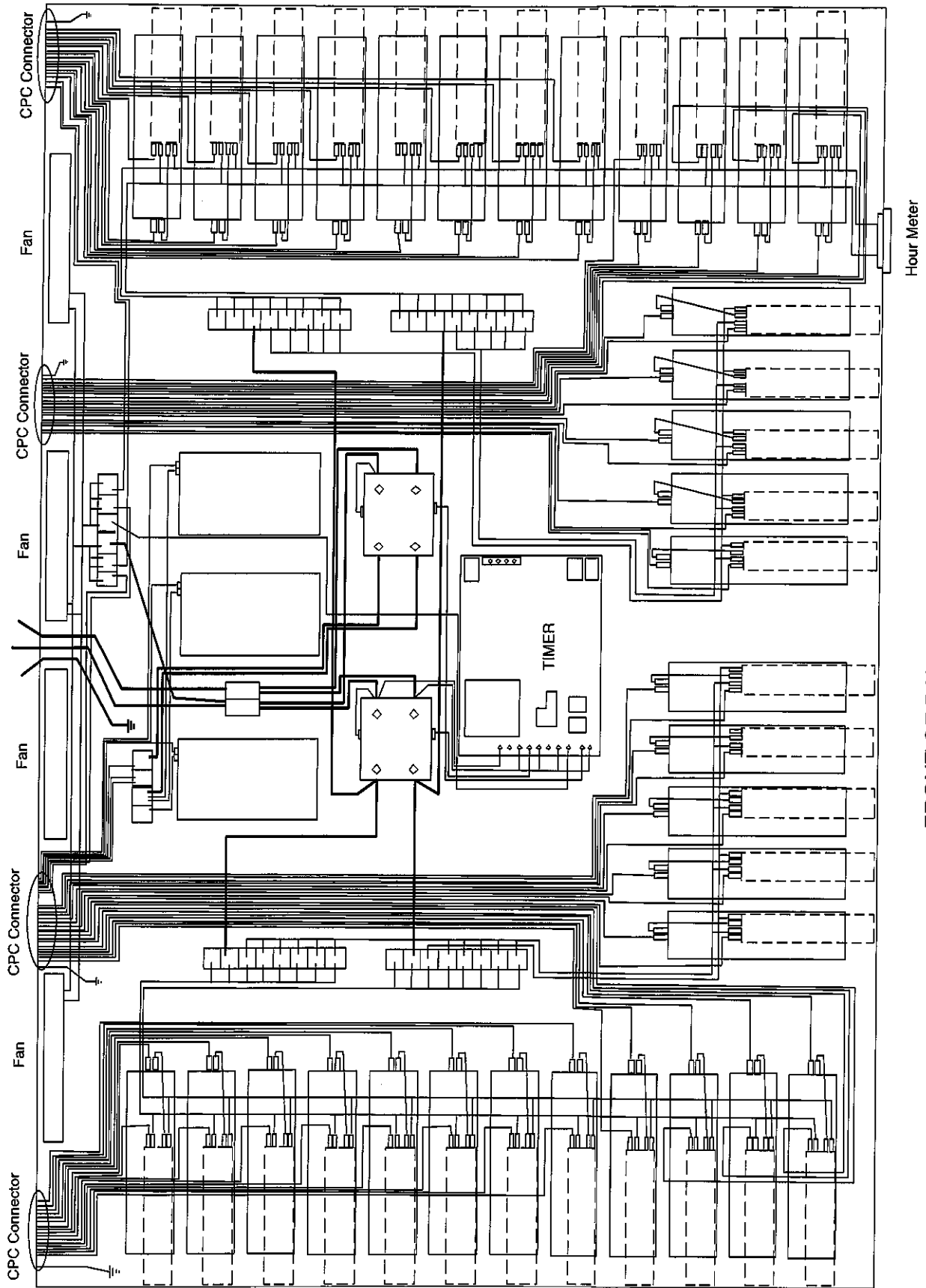

FRONT OF BALLAST BOX

# 134 & 128 SERIES WIRING DIAGRAM BALLAST BOX

## REAR OF BALLAST BOX

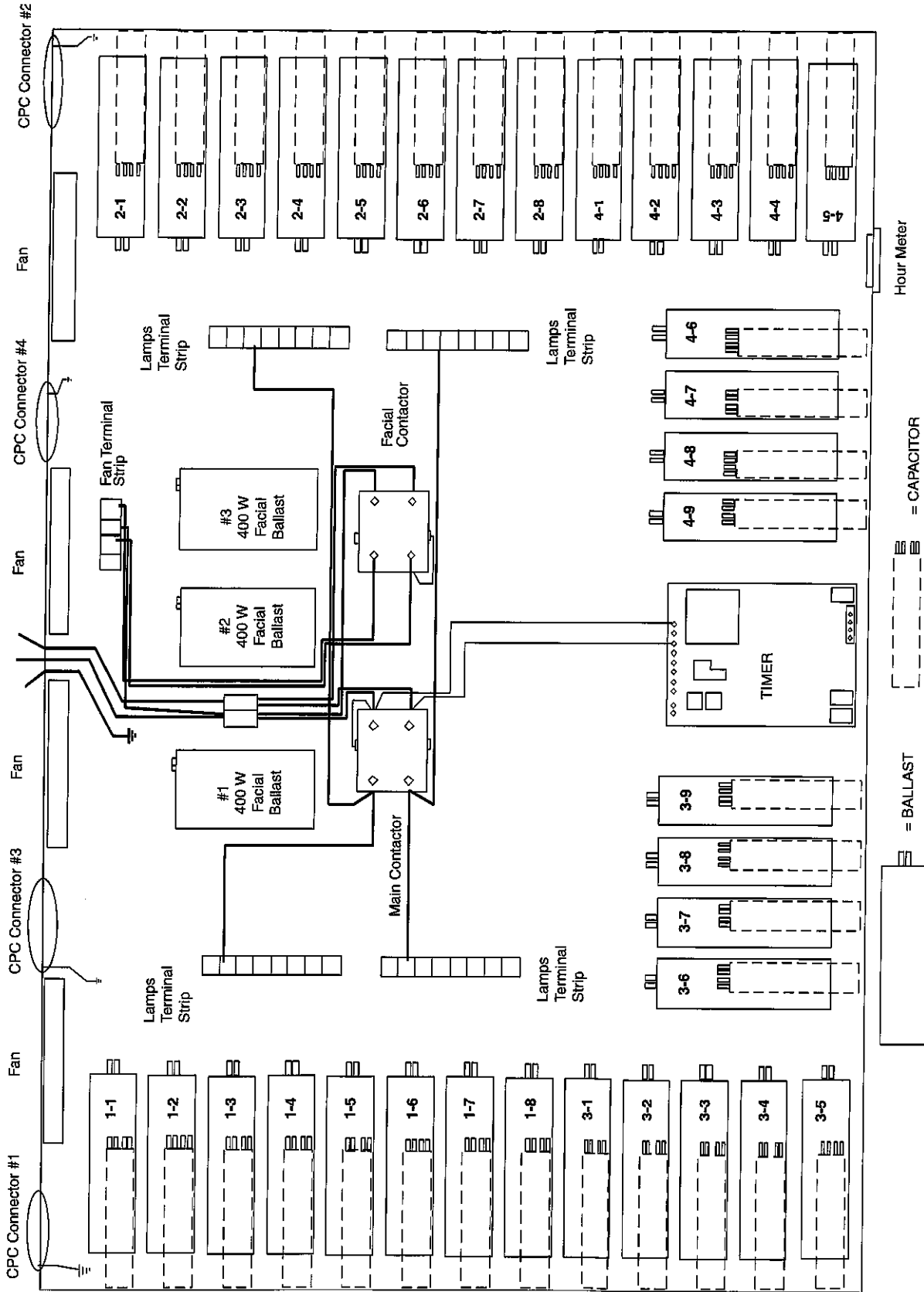

## FRONT OF BALLAST BOX



# 134 & 128 SERIES ELECTRICAL OVERVIEW

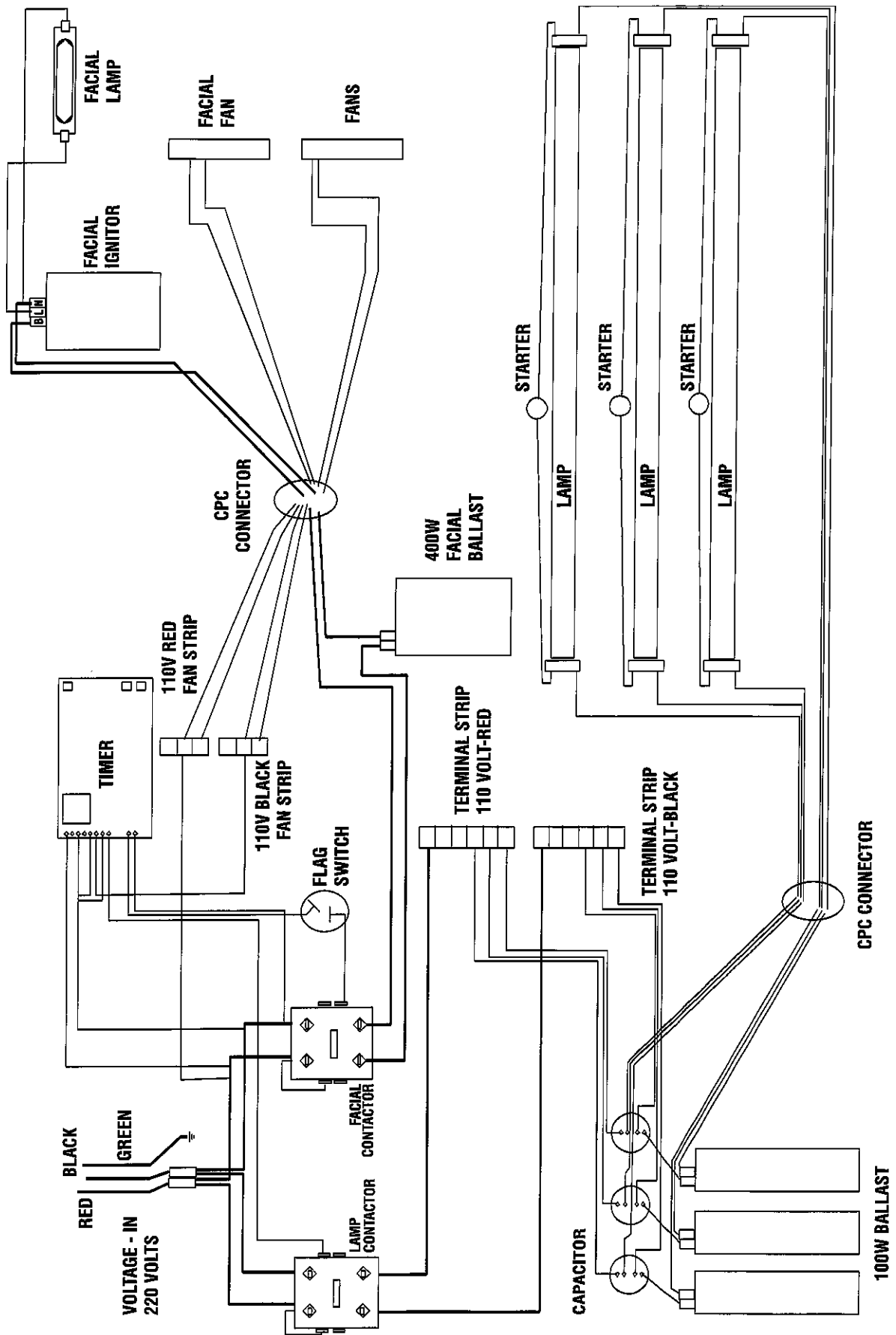

# 134 & 128 SERIES ELECTRICAL OVERVIEW

