



Specifications, Requirements and Responsibilities

Welcome to Mystic Tan

Welcome to the Mystic Tan family. We're excited to have you on board and know that you're anxious to spread the word of Mystic Tan and UV-Free Tanning. Before booking any media (electronic/print) or Grand Opening Events, please keep in mind that the installation process is unique to each salon. Therefore, due to unforeseen circumstances such as shipping or installation delays, the exact time and date of completion can vary. We strongly advise against booking any advertising media until the booth installation is complete.

Salon Responsibilities

It is very important that you read and fully understand your responsibilities outlined in this document. Following these outlined responsibilities will insure your Mystic Tan booth installation is completed in a timely manner.

Important: No installation will be scheduled until all requirements are completed. After completion, fax the signed Requirements and Responsibilities Check List to Fax # 972-267-5551 or call 877-668-8826 x. 2008 Before any equipment is delivered all balances must be paid in full. (Refer to page 4).

The salon is responsible for the following requirements listed in this document (see page 4). It is imperative that all requirements are met prior to the arrival of the Mystic Tan installer. The following charges may be incurred if all requirements and responsibilities are not completed:

- You will incur a charge of \$75.00 per hour plus related expenses if any additional time or work is required for equipment installation or training.
- You will incur a rescheduling charge of \$750.00 if the salon is not ready and the Installer has to return on a later date.
- You must give a minimum two-week notice of any scheduling changes prior to the installation date. Not doing so will result in a rescheduling charge of \$750.00.

Installers Responsibilities

Mystic Tan installers are responsible for the following items:

- Installation of the Mystic Tan Booth.
- Installation of the Air Compressor (ground level only).
- Connection of the in-room plumbing lines (drainage and water supply) to the Mystic Tan Booth.
- Equipment training.

Equipment Specifications:

Room Size: (Floor Space) 8' x 7' [minimum] (Ceiling Height) 8' [minimum]	Booth Dimensions: 82" length x 48" width x 90" height (With door open) 76" width
Plumbing: (Drainage) 1" [ID] Above or below ground service. (Water Service) ½" [ID], 8 [GPM] 55 [PSI].	Electrical: (Tanning Booth) 110V 20-amp (Compressor) 110V 20-amp [dedicated]
Note: A minimum of 55-PSI water pressure is needed to properly wash down the unit.	
Additional Technical Information available at Mystic Tan's Technical Support Line: 877-668-8826.x 2551	

Dedicated Room

(Room Floor Space must be a minimum of 8'x7')

The Mystic Tan booth should have a room dedicated solely for its use. The floor space of the room must be a minimum of 8' X 7'; slightly larger is better. The floor of the room must be level and free of obstructions. Preferred floor cover type is tile or linoleum. Carpeted floors are not recommended. Sufficient overhead room lighting is required (fluorescent is recommended). Your Mystic Tan booth is provided with a frosted Lexan® top, which allows light inside the booth.

Refer to page 5 (Room Layout Diagrams: 1,2).

Equipment Shipment, Unloading and Storage

(More than one person will be required to unload)

The Mystic Tan booth is usually shipped up to one week prior to the installer's arrival. The booth is shipped in several large boxes. They will need to be unloaded and stored near or inside the dedicated Mystic Tan room. More than one person will be required to unload the equipment. Boxes can be separated and removed individually. Do not depend on the truck driver or delivery person to help with unloading the boxes. Mystic Tan requests that all boxes remain un-opened. In the event that any of the boxes have been opened, Mystic Tan will not be responsible for damaged or missing parts. **Refer to page 6 (Box sizes and weights Diagram-S).**

Note: Please make note of any apparent damage on the delivery receipt prior to signing and accepting the shipment. Mystic Tan will provide the appropriate tracking information allowing you to monitor the shipments' estimated arrival date and time.

Equipment Training

(Arrange for the appropriate personnel to attend)

You will need to provide the appropriate personnel and time for training. The training session is a complete overview of the Mystic Tan booth and how it works. You will be trained on how to tan a customer, the day-to-day equipment operation, maintenance and equipment troubleshooting. Training is approximately 1 hour and will take place upon completion of the equipment installation, and is performed by the equipment installer. Arrange for the appropriate personnel to attend, such as a store manager or maintenance personnel. It is not necessary for everyone to attend this training, just your key individuals that will be able to train all additional employees and new hires.

General Contractor Services

To stay in compliance with city codes, **you must consult** with your electrical and plumbing contractors. Mystic Tan equipment is compliant with CSA and CE Certification guidelines. Local codes vary and are not the responsibility of Mystic Tan, Inc.

Electrical

Mystic Tan Booth (110 VAC, 20-amp outlet):

The Mystic Tan booth requires 110 VAC, 20-amp **GFCI** outlet (Ground Fault Circuit Interrupter). It only requires .5 amps AC Current to operate booth.

Refer to page 7 (Electrical Diagram 3) also see page 11

Compressor (110 VAC, 20-amp (dedicated):

The Air compressor requires 110 VAC, 20-amp (**dedicated**) outlet. A six-foot (6') power cord is provided with the air compressor. The use of any type of extension cord is prohibited and will void the air compressor warranty.

Refer to page 7 (Electrical Diagram 4)

Important: Under no circumstances will Mystic Tan installers be responsible for any electrical service installation.

Plumbing

The MyMyst booth is capable of operating without in-room plumbing. Included are a stand-alone drainage tank system and a drain pump. However, Mystic Tan highly recommends that you install in-room plumbing for ease of daily operations.

Supply Line (½" ID with ¾" GHF Male Connection with on/off valve):

An in-room water supply line is required for the Automated Cleaning Cycle. The water supply line specifications are ½" ID with ¾" GHF Male Connection equipped with an on/off valve (a typical washing machine connection). The Supply Line should have a minimum of 55 pounds of pressure (8 gpm). **Note: A minimum of 55-PSI water pressure is needed from the supply line to the Mystic Tan booth to properly wash down the unit.** We recommend that the water supply to the Mystic Tan booth be turned off each night using the shut off valve. This will protect your salon from water damage should the hose connecting your booth to the water supply ever fail. The shut-off valve should be easily accessible and located at the end of your in-room water source. Using the shut-off valve located in the Mystic Tan booth will not protect the salon from water damage caused by a failed connecting hose. Mystic Tan is not responsible for the integrity of supply line hoses. To maintain compliance with city codes, please consult with your plumbing contractor. **Important: The water supply must be turned off at the end of each day.**

Refer to page 8 & 9 (Plumbing Diagrams 5,6) also see page 11

Drain Line (1" ID with ¾" GHF Male Connection, PVC or Copper):

An in-room drain line is required to remove rinse water from the Mystic Tan booth after each cleaning cycle. The in-room drainpipe specifications are 1" ID with ¾" GHF Male Connection (PVC or Copper suggested). The Mystic Tan booth is equipped with a fully automatic discharge pump for water removal. The discharge pump (provided) is capable of pumping 12' in height (maximum). Height and Length: Not to exceed 60' (60' of head pressure or approximately 30 PSI). The discharge pump will also remove water at a rate of 2.8 [GPM]. A six-foot (6') drain hose is provided to connect from the drain pump to the wall connection. **Not following these guidelines will cause premature pump failure resulting in the voiding of your pump warranty.**

Refer to page 8 & 9 (Plumbing Diagrams: 5,6) also see page 11

Note: A backflow prevention device may be required in your municipality. The salon is responsible for consulting a qualified plumber and contractor.

Air

Compressor room location and size: (Room - 28" Height X 24" Length X 24" Width)

Compressor: (23" Height X 18" Length X 18" Width) - Amp Draw: 15

The Mystic Tan booth requires compressed air for its operation. A compressor is included with the Mystic Tan booth. Due to noise level, the air compressor should be located away from the tanning room. The air compressor should always be located in an easily accessible, **ground** location for periodic maintenance. A six-foot (6') power cord is provided with the air compressor. The use of any type of extension cord is prohibited and will void the air compressor warranty. **Refer to page 7 (Air Line Diagram 4)**

Compressor Air line (3/8" ID for hose or piping lengths up to 100'):

To connect the air compressor to the Mystic Tan Booth, you can purchase a ready-made air hose of the proper length, or install air piping with connection hoses. The inside diameter (ID) should be no less than 3/8" for hose or piping lengths up to 100'. For lengths over 100', ½" ID is needed. Ready-made air hoses can be found at Grainger, Home Depot, Lowes or similar industrial companies.

Refer to page 10 (Air Line Diagrams 7,8) also see page 11

Salon Access

(Installer may need early access to your salon)

Because there is much to be accomplished, the installer will need full and complete access to the salon (earlier or later than your normal operating hours).

Salon Requirements and Responsibilities Check List :

- Compliance with city codes:** Consult with your electrical and plumbing contractors.
- Unload Booth Shipment:** Appropriate personnel (no less than two) available to unload shipment from freight truck.
- Dedicated Room:** (Room Floor Space must be a minimum of 8'x7') (Ceiling height 8'). Room must be empty and accessible.
- Electrical:** (Mystic Booth): Dedicated room must have a 110 VAC, 20-amp GFCI outlet (Ground Fault Circuit Interrupter).
- Electrical:** (Compressor): The location must have a 110 VAC, 20-amp (**dedicated**) outlet.
- Plumbing:** (Supply Line): In-room cold water service with 55 pounds of pressure (8 gpm). Equipped with an on/off valve and a 3/4" male (typical washing machine hose connection). **Note:** A minimum of 55 PSI of water pressure is needed to properly wash down the unit.
Important: The water supply must be equipped with a shut-off valve.
- Plumbing:** (Supply Line Hose): In room supply line - 6' to 8' long, 1/2" ID, high-pressure supply hose (typical washing machine hose). Also, Mystic Tan recommends a garden hose (minimum of 15' length) with a sprayer attachment and a brass Y valve to split the water sources. *Mystic Tan is not responsible for the integrity of supply line hoses.*
- Plumbing:** (Drain Line): In room drainpipe -1" ID with 3/4" GHF Male Connection PVC or Copper.
Note: The drain pump (provided) is capable of pumping 12' in height (maximum), Height and Length: Not to exceed 60'.
- Compressor:** (Location): A location with a minimum space of 28" tall X 24" long X 24" wide (Ground level), with required electrical specifications.
- Compressor:** (Air line): Air supply line from compressor to tanning room with connections. A 3/8" ID air hose with connections, made to the appropriate length. (see page 11, diagram 8A). If using air piping, use two (2) air hoses of appropriate length with required connections (see page 10, diagrams 7,8).
- Salon Access:** Arrangements have been made for access to the salon with the installer.
- Bath Towels:** Bath towels on-site for customers and training sessions (12 minimum).
- Staff available for training:** Key individuals such as Owner, Store Manager or Maintenance Personnel.

I agree that all of the requirements listed above have been completed.

Salon Owner Signature _____ Date: _____

Important: No installation will be scheduled until all requirements are completed. After completion, fax the signed Requirements and Responsibilities Check List to Fax # 972-267-5551 or call 877-668-8826 x. 2008 Before any equipment is delivered all balances must be paid in full (see page 4).

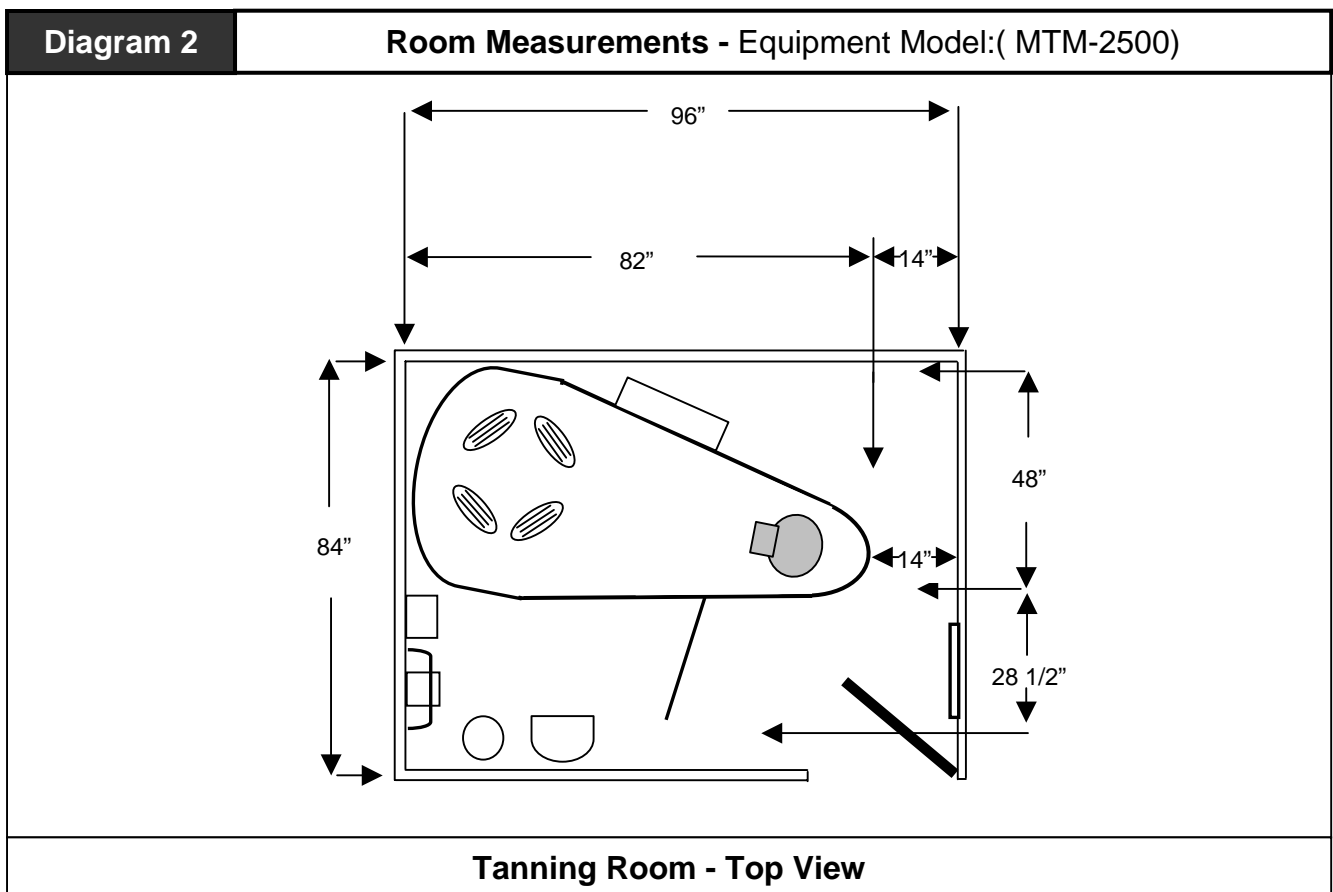
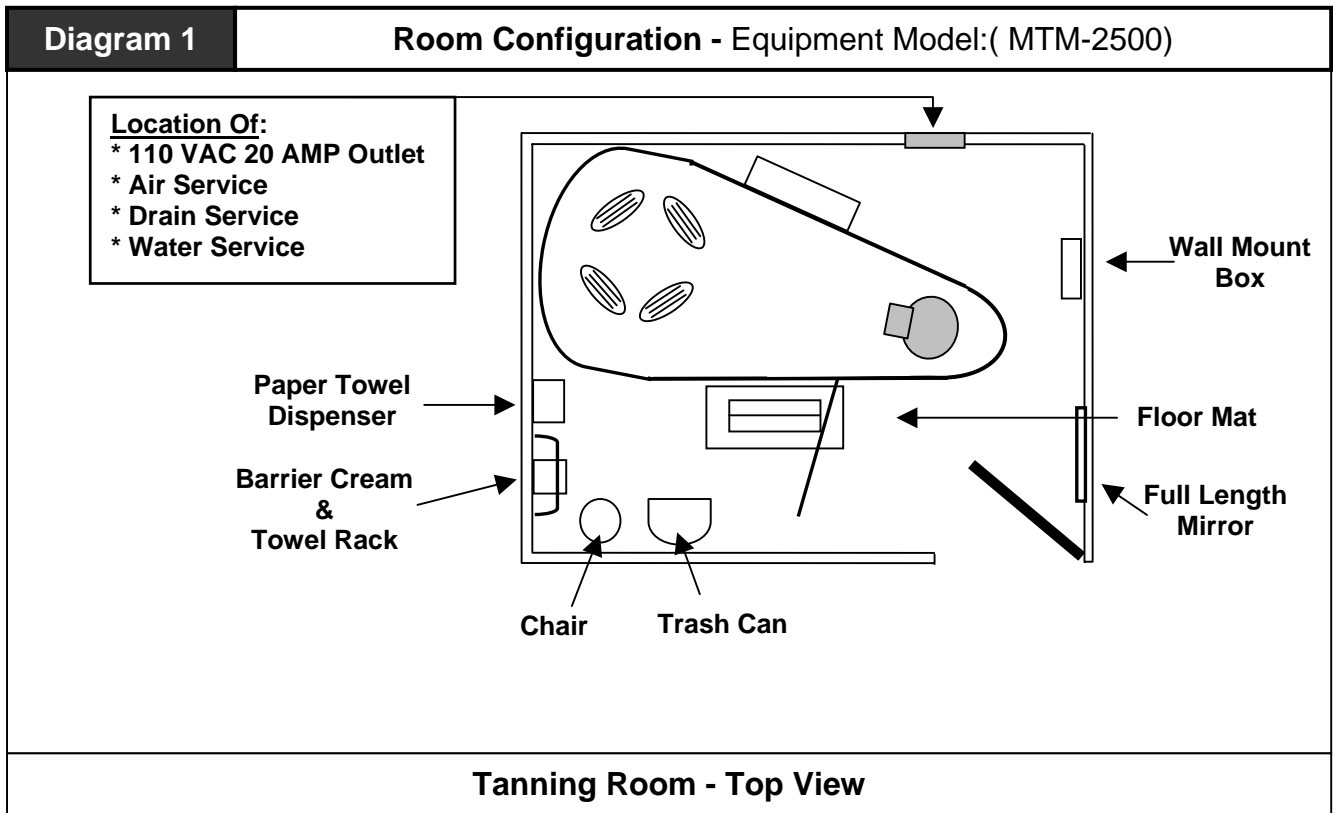
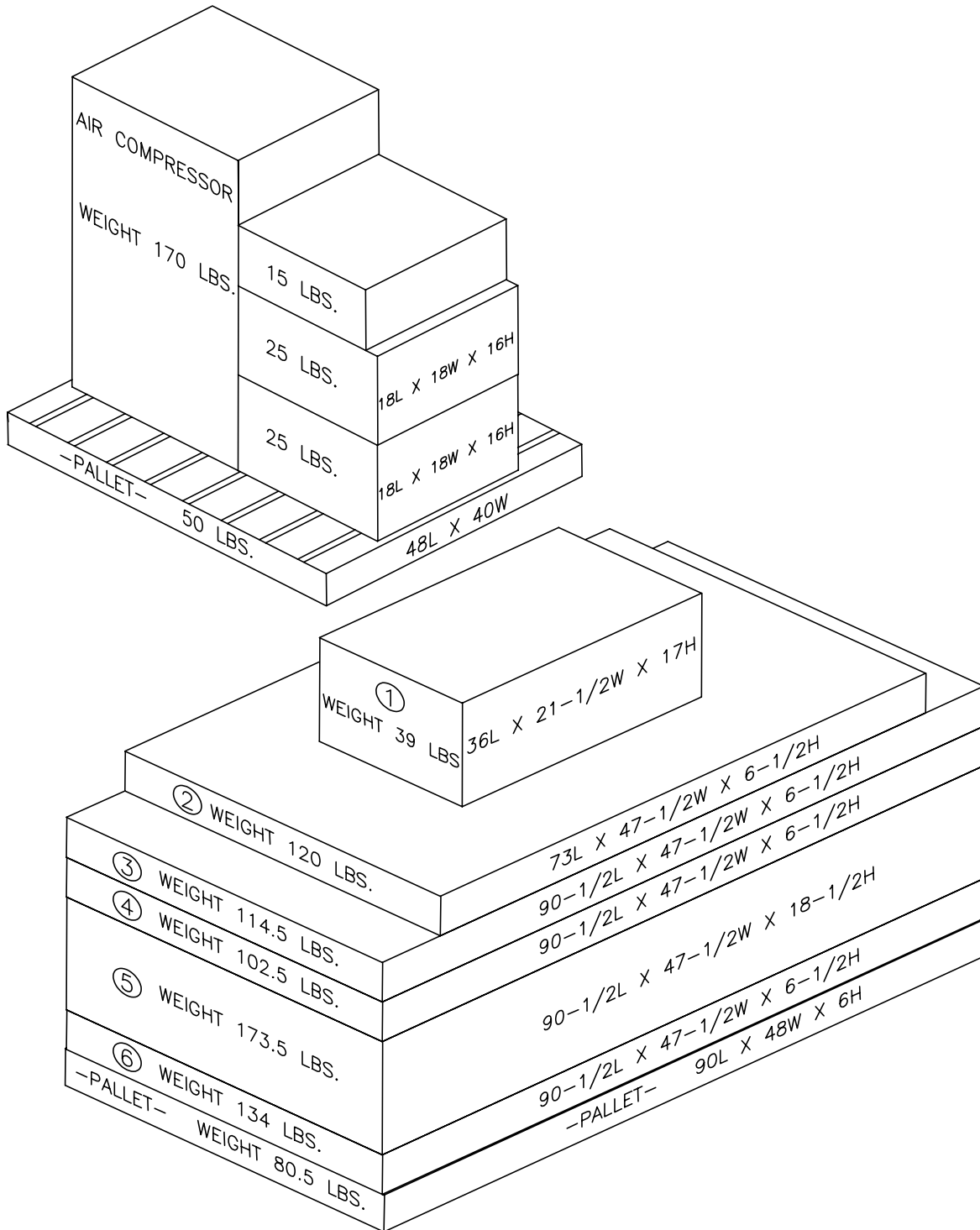

Diagram S

Shipping Configurations - Equipment Model:(MTM-2500)



(Actual box sizes and weights may vary)

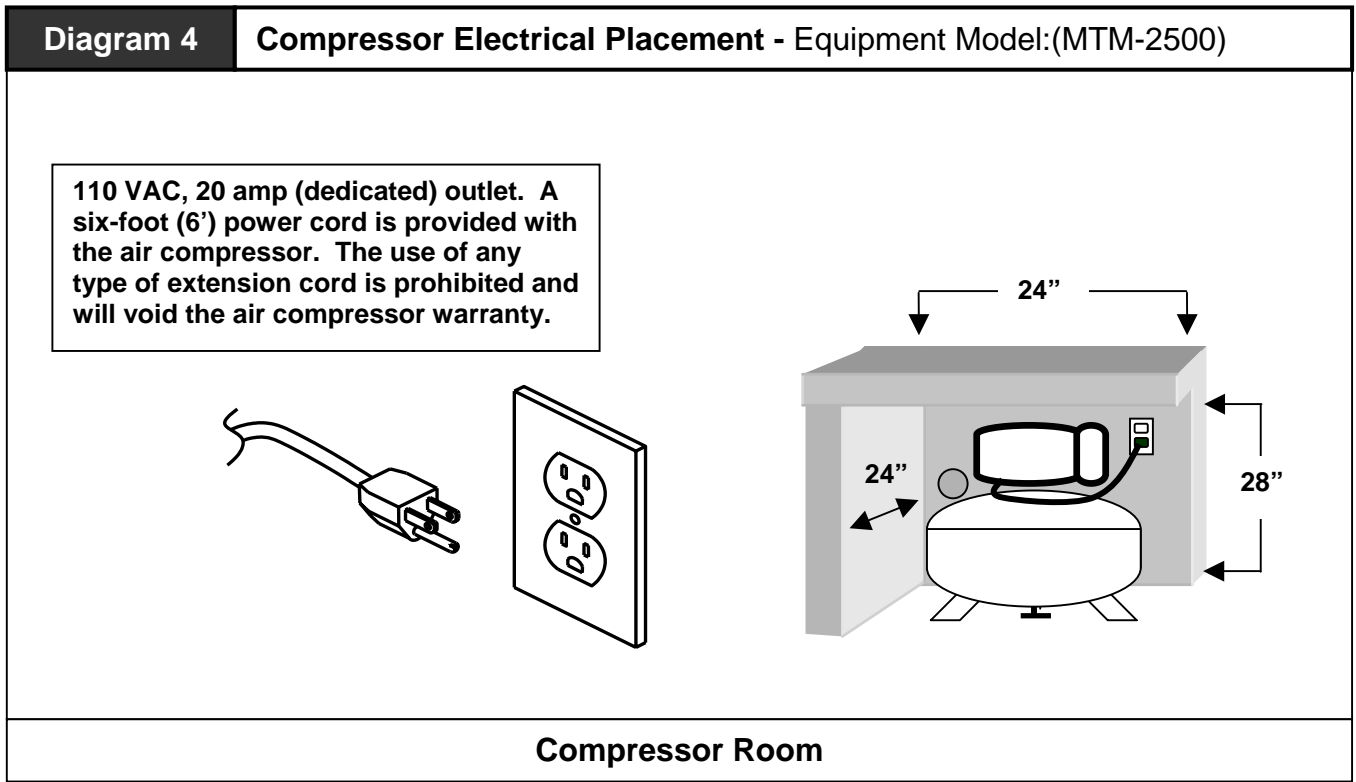
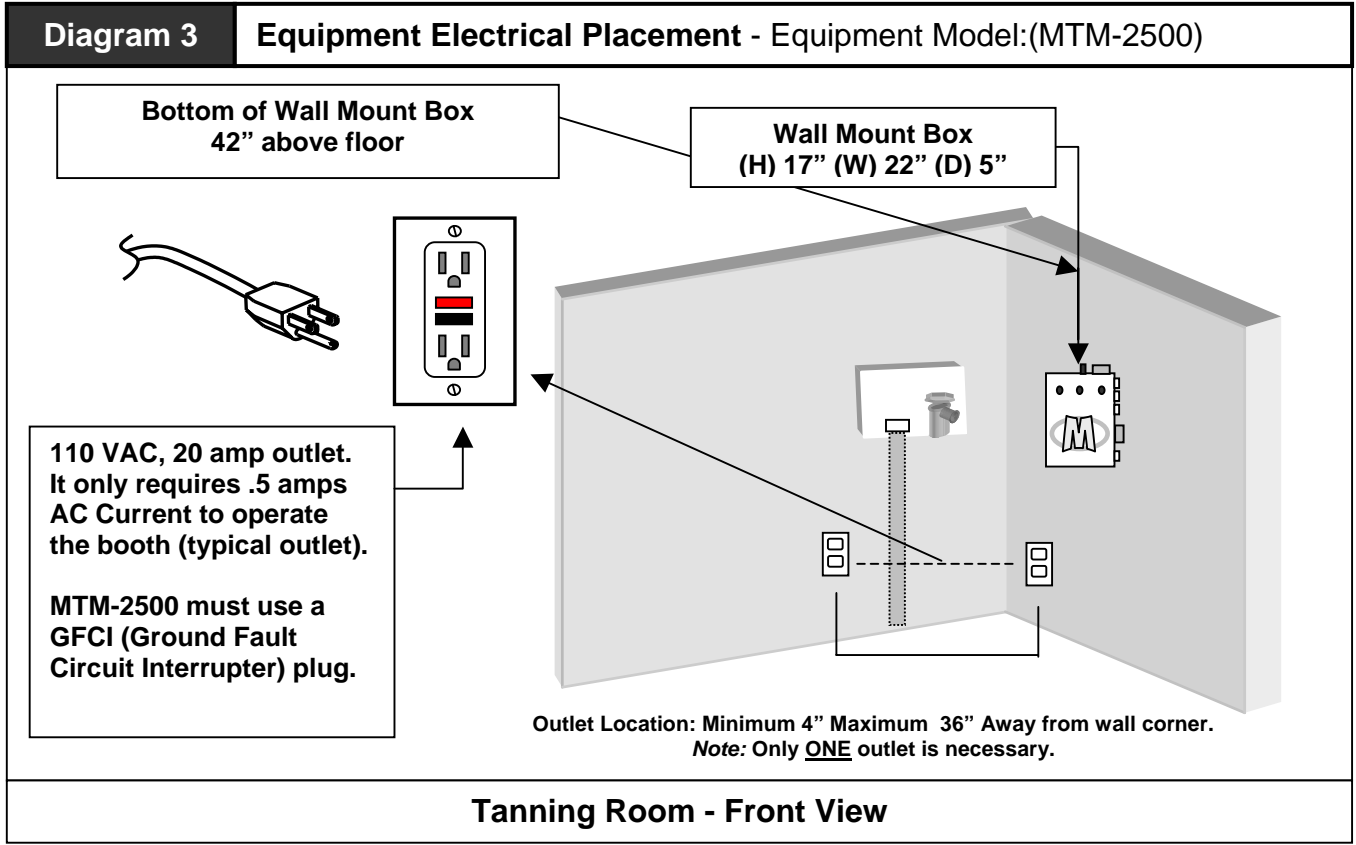
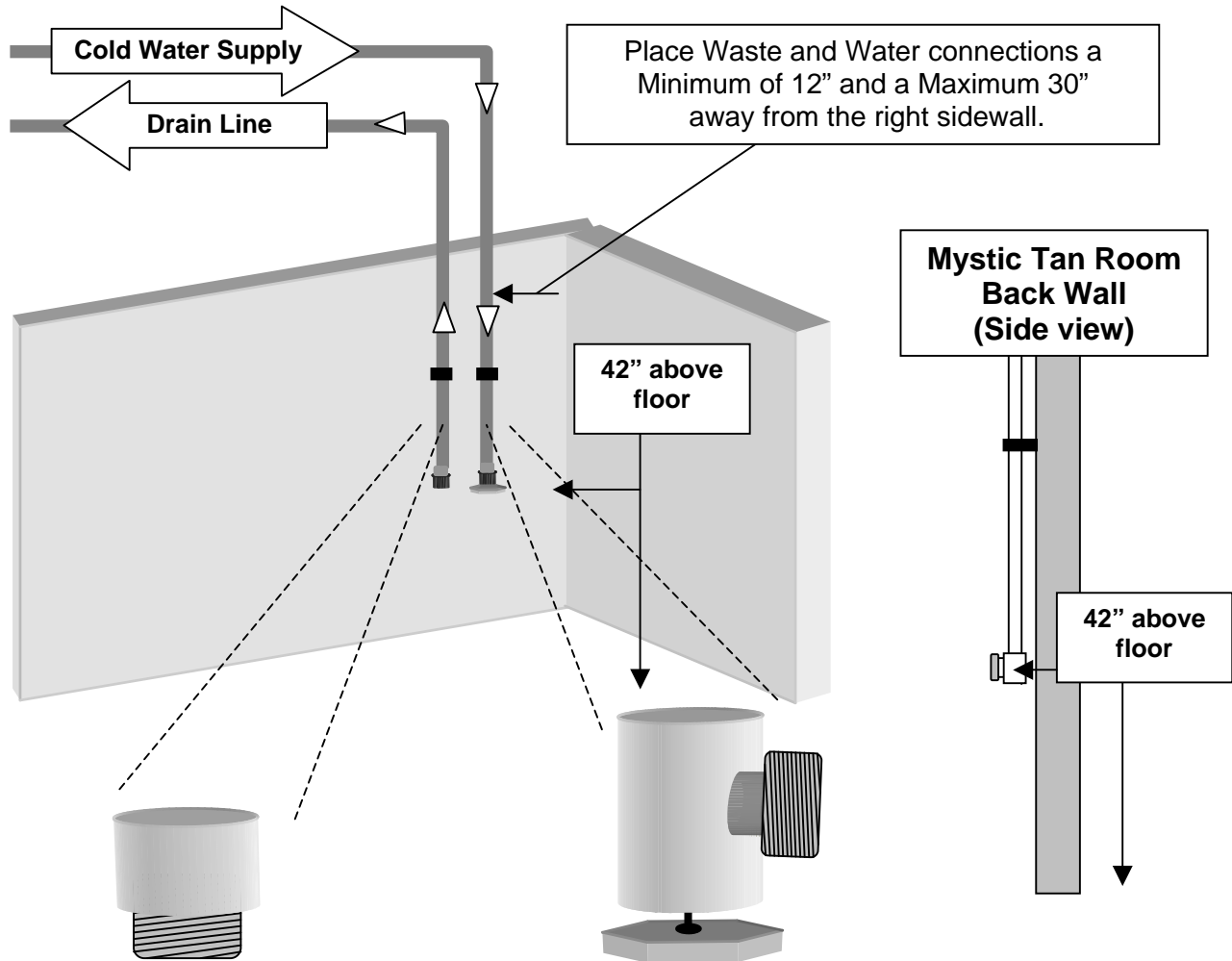

Diagram 5

Above Ground Plumbing - Equipment Model:(MTM-2500)

Important (please read):

The discharge pump (provided) is capable of pumping 12' in height and 48' in total length (60' of head pressure or approximately 30 PSI). The discharge pump will also remove water at a rate of 2.8 [GPM]. A six-foot (6') drain hose is provided to connect from the drain pump to the wall connection. **Not following these guidelines will cause premature pump failure resulting in the voiding of your pump warranty.**



Note: This Connection is a 3/4" GHF Male.

Note: This Connection is a 3/4" GHF Male, with on/off valve.

Important: We recommend that the water supply to the Mystic Tan booth be turned off each night using the recommended shut-off valve.

Diagram 6

In-Ground Plumbing (New Construction) - Equipment Model:(MTM-2500)

Important (please read):

The discharge pump (provided) is capable of pumping 12' in height and 48' in total length (60' of head pressure or approximately 30 PSI). The discharge pump will also remove water at a rate of 2.8 [GPM]. A six-foot (6') drain hose is provided to connect from the drain pump to the wall connection. **Not following these guidelines will cause premature pump failure resulting in the voiding of your pump warranty.**

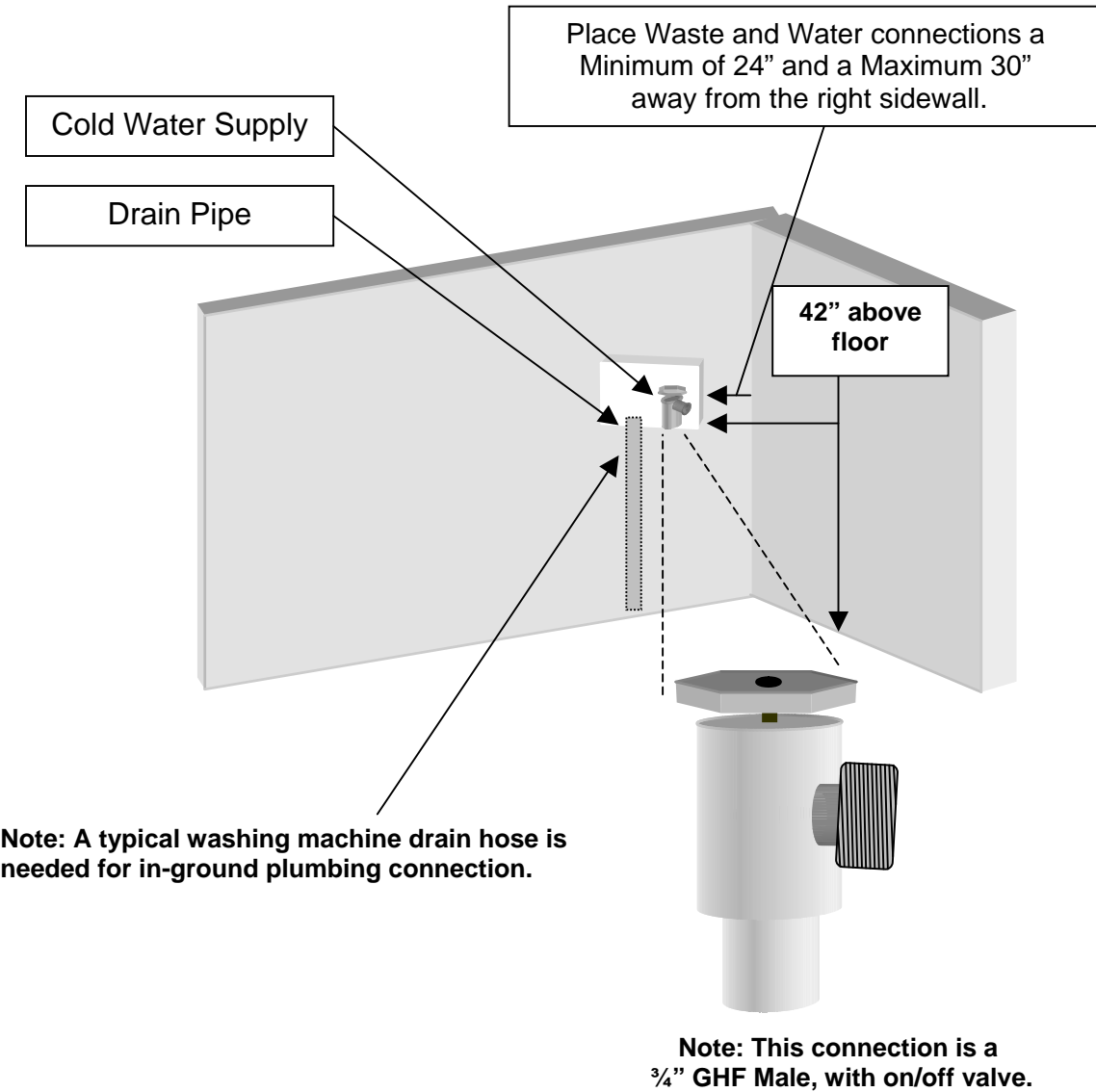

Important: We recommend that the water supply to the Mystic Tan booth be turned off each night using the recommended shut-off valve.

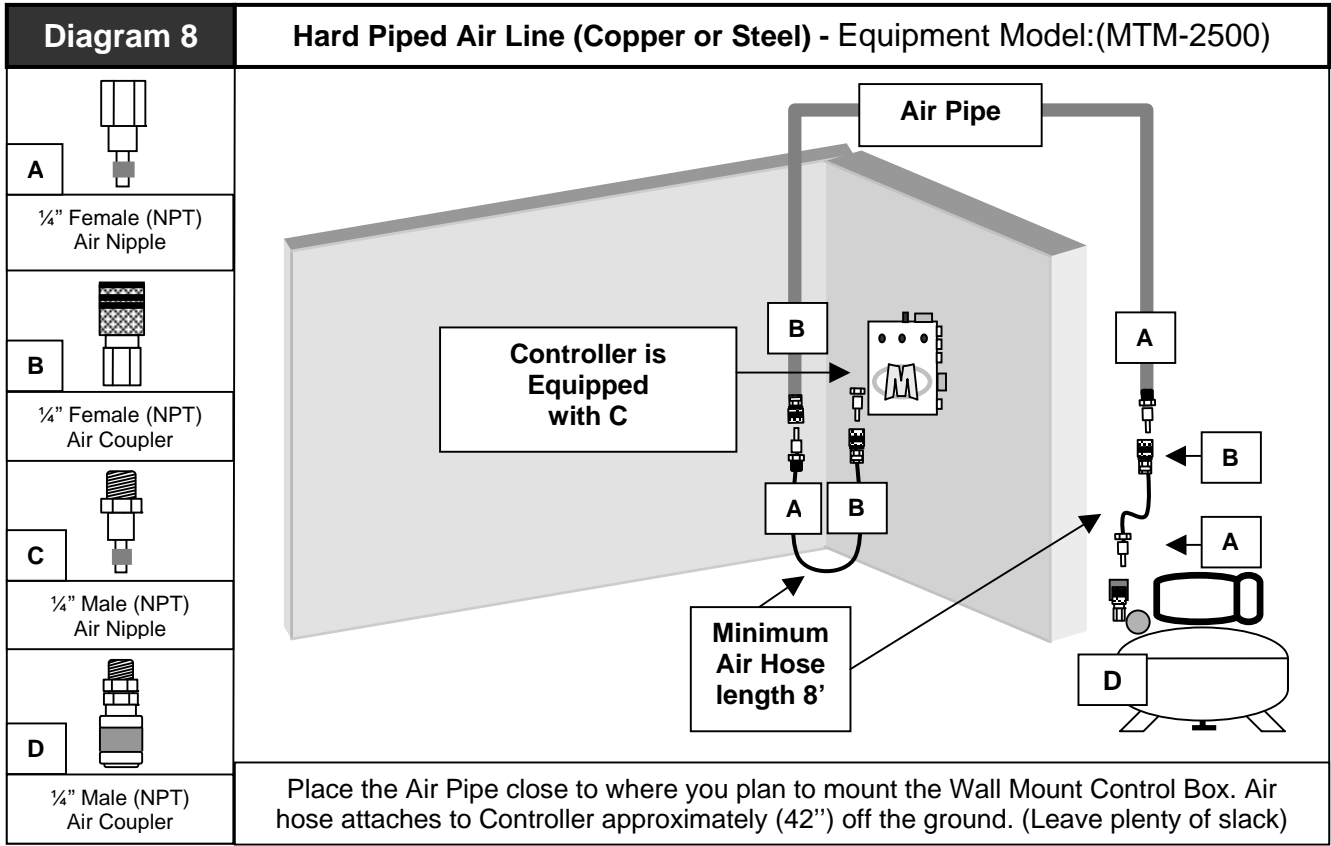
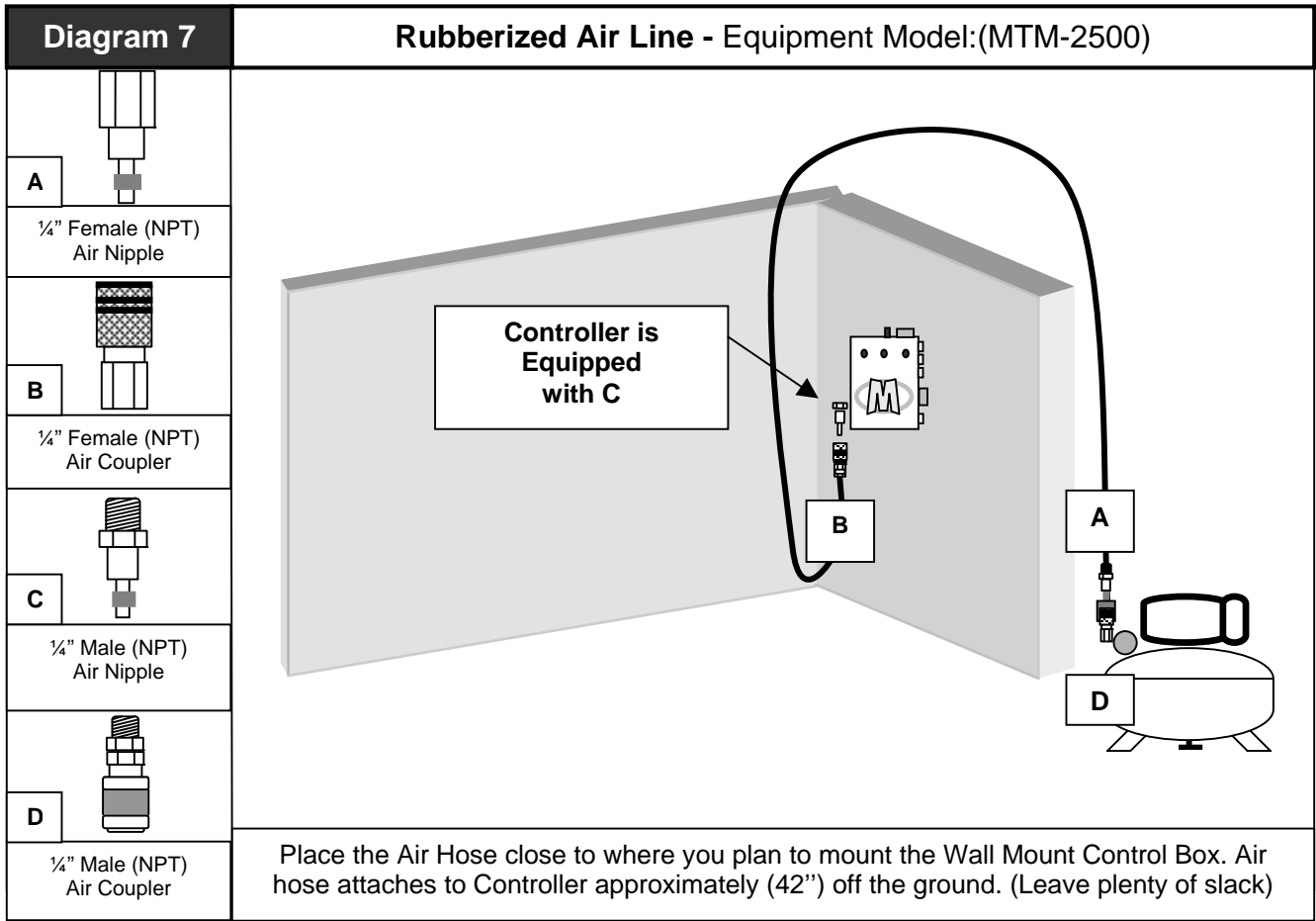
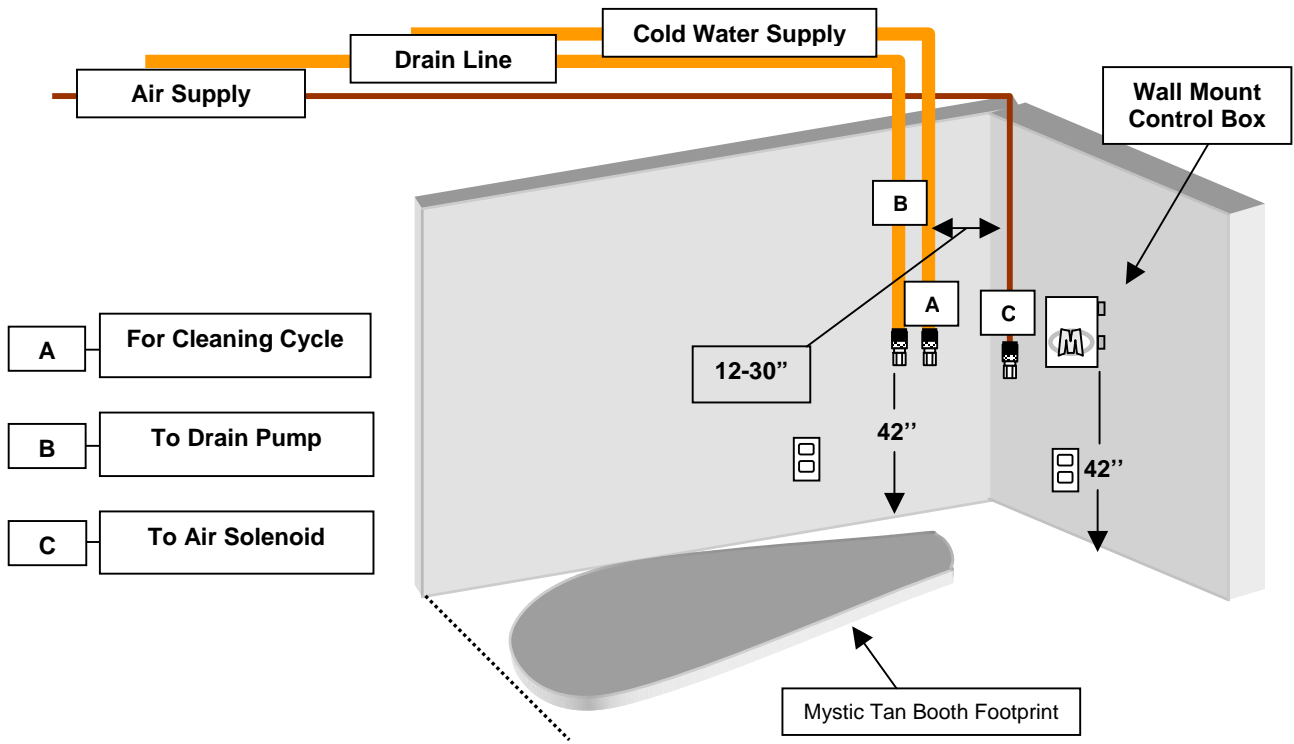

Diagram 9

Plumbing, Air and Electrical Overview - Equipment Model:(MTM-2500)



Important: Plumbing shut-off valve must be accessible at all times.

Diagram 10

Plumbing, Air and Electrical Overview - Equipment Model:(MTM-2500)

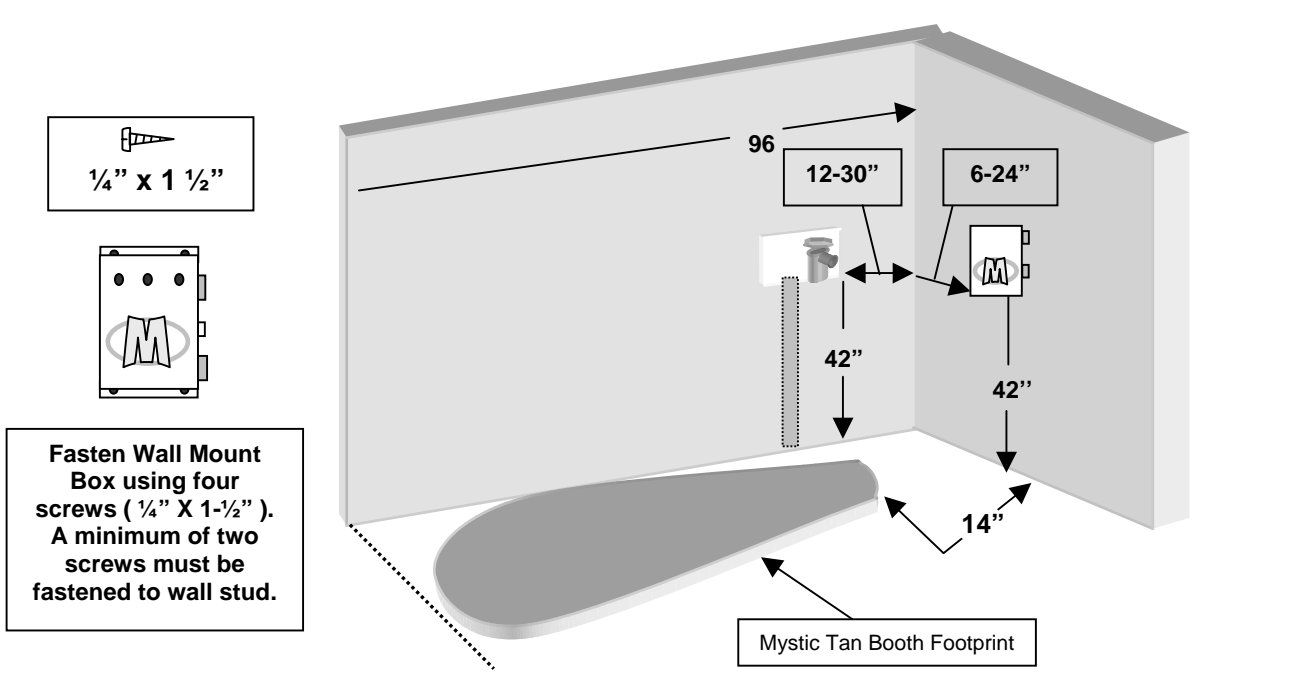

Important: Plumbing shut-off valve must be accessible at all times.