

megaSun[®]
by KBL



**Operation and
Maintenance
megaSun 4500**

Copyright und Warenzeichen

Printed in Germany

© Copyright 2005 KBL-Solarien AG

This documentation covers only products manufactured by KBL-Solarien AG. This documentation must not be duplicated, photocopied, translated or stored on any electronic medium or in a machine-readable form, neither in whole or in part, without prior written consent by KBL-Solarien AG.

Up-to-date manuals are available under <http://www.kbl-support.de>



is a registered trademark of KBL-Solarien AG.

Certified according to DIN ISO 14001

Only original spare parts – especially tubes and burners – have to be used, otherwise operating authorization and terms of guarantee will become invalid.



KBL-Solarien AG ·

Ringstraße 24-26 · 56307 Dernbach · Germany

fon +49(0)2689.9426-0 · Fax +49(0)2689.9426-66

eMail megaSun@kbl.de · Internet: www.megaSun.de

Table of content

1. General safety information	5
2. Operating during the tanning session.....	6
2.1. Operating panel.....	6
2.2. Functions.....	8
3. Maintenance of the unit.....	11
3.1. Cleaning and care	11
3.2. Dismantling the acrylic panes.....	11
3.3. Filter panes	14
3.4. Tubes and facial tanners	16
3.5. Removing the burners	17
3.6. Unit lighting.....	18
3.7. Canopy drive	20
3.8. Filter mats.....	22
3.9. Cooling and exhaust air.....	23
3.10. Air-conditioning unit.....	24
3.11. Condensate pump	25
4. Technical data.....	26
4.1. Data that is common to all unit models.....	26
4.2. Views	27
4.3. megaSun 4500 Super.....	27
4.4. megaSun 4500 Super Power	28
4.5. megaSun 4500 Ultra Power	28
4.6. megaSun 4500 XXL Super Spaghetti.....	29
4.7. megaSun 4500 XXL Super Power Spaghetti	29
4.8. megaSun 4500 XXL Ultra Power Spaghetti	29
5. Wiring diagrams.....	30
5.1. Mains voltage	30
5.2. External audio signal	31
5.3. Music Preselection	32
5.4. External Timer	33
6. Service mode - inductive	34
6.1. Service level I - inductive.....	35
6.2. Service level II - inductive.....	36
7. Service Mode CPI.....	36
7.1. General information and structure	36
7.3. Service level I - CPI.....	40
7.4. Service level II - CPI.....	45
7.5. Error messages	46
8. Tanning instructions	47
8.1. General tanning instructions	47
8.2. megaSun 4500 Super, ind. / CPI, UV type 3	48
8.3. megaSun 4500 Super Power, UV type 4.....	48
8.4. megaSun 4500 Super Power, ind. / CPI, UV type 3.....	49
8.5. megaSun 4500 Ultra Power, UV type 4.....	49
8.6. megaSun 4500 Ultra Power, ind. / CPI, UV type 3.....	50
8.7. megaSun 4500 XXL Super Spaghetti, UV type 4.....	50
8.8. megaSun 4500 XXL Super Power Spaghetti, UV type 4.....	51
8.9. megaSun 4500 XXL Ultra Power Spaghetti, UV type 4.....	51
9. Index	52

1. General safety information

Please observe the following safety information:

Tanning times Never exceed the recommended duration of a tanning session.
See Section 8 Tanning Instructions

Timer The tanning units may only be operated by a safety timer that complies with any applicable standards.
KBL-Solarien AG recommends the following timer model:
megaTimer KBL article no. 9100025000

Disconnecting Before opening the unit switch off the fuses to disconnect the system from the voltage supply!



Facial tanners Do not operate the tanning system if a filter pane is defective.
Section 3.3 Filter panes

Technical parameters The data indicated in the tanning schemes are based on the assumption that both tubes and burners are replaced at regular intervals. See Section 3.4 Tubes and facial tanners
With regard to tube replacement remember to reset the control and the working hour counter of the tubes.
See Section: 6.1 Service level I in inductive mode

Mechanical parts The canopy drive has to be serviced regularly with each tube replacement. This includes the replacement of the drive rope after 3,000 hours of operation.
See Section 3.7 Canopy drive

Cleaning Do not use any cleansing agents other than the ones approved by KBL Solarien AG.
See Section 3.1 Cleaning and care

2 Operating during the tanning session

General

The start of the tanning program depends on the studio control system. If a simple coin-operated system has been installed, the tanning program is started by inserting coins or tokens. After the warm-up time has elapsed, the tanning lamps are turned on automatically. If the touch key „Start“ is pressed during the warm-up time, the lamps turn on immediately. The facial tanners are always switched on after a certain delay.

2.1. Operating panel

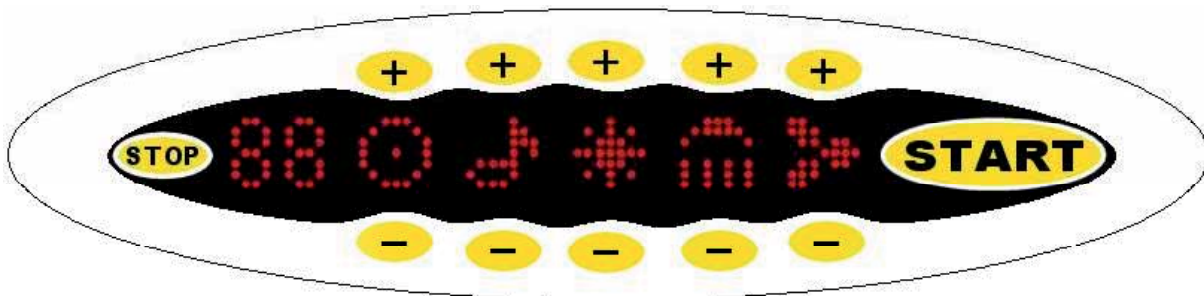

Fig. 2-1: Operation with processor KBL /5, which means the sunbed is inductively controlled and has no optional features except external music (with or without channel selection)

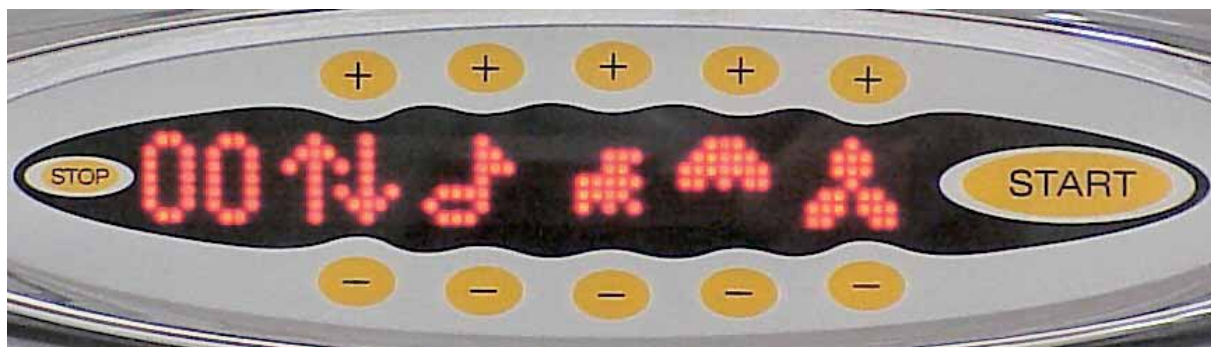

Fig. 2-2: Operation with processor KBI/4, which means the sunbed is inductively or electronically controlled (CPI) and has - beside external music (with or without channel selection) - several optional features: megaVoice, mp3-sound-box and air conditioning unit.

A running text is displayed prior to starting the tanning program. Otherwise, the operating panel displays the symbols explained below.

As soon as the unit has been enabled by the corresponding signal from the coin-operated studio control system, the tanning bed is ready to be operated by touching the respective sensor field. Any input is confirmed by a beep tone. The elapsed tanning time is permanently indicated on the numerical display (count up to total tanning time released).



A function is switched on by pressing the plus sensor; this sensor is also used for increasing the value step by step. To set the maximum value (e.g. fan speed), the sensor field has to be pressed repeatedly until the maximum value appears.



A function is switched off by pressing the minus sensor; this sensor is also used for decreasing the value step by step. To set a lower value (e.g. volume), the sensor field has to be pressed repeatedly until the desired value is reached.



You can use this touch key to switch on the apparatus during the warm-up time.

If the tanning session has been interrupted by means of the „Stop“ key, it can be continued after touching the „Start“ key once again, provided the coin-operated counter has not run down yet.

The numerical display shows the tanning time.

When the tanning time is over, the running text will appear again.



By pressing this touch field for at least 2 seconds you can terminate the tanning session prematurely.

Run time



While the tanning program is running, the run time is indicated in this field. In case the volume of the audio system is adjusted, the value set – between 0 and 99% - is displayed here for a short time. In case the fan speed is adjusted, the value set - between 20 and 99% - is displayed here for a short time.

2.2. Functions



These double arrows point to some more menus if the sunbed is operated with processor KBL/4. The following menus are explained in more detail below:

Channel selection



This function is only displayed in case a music / audio system with channel selection is provided with the system or if the next track of the MP3 player is to be chosen (KBL/4). In this case, the function can be found in the next menu level (double arrows).

Volume



You can adjust the volume of the music by touching the „+“ and „-“ fields. When adjusting the volume, the current setting is displayed in the numerical field as a value between 0 and 99% for a short time. Press the respective sensor key several times until the desired value is reached.

To switch off the music, set the volume to 20% and press for some time the „-“ button until the music is off.

Air conditioning unit



During a tanning session the air-conditioning unit is switched on and off by pressing the „+“ or „-“ sensor fields. Once being switched off, the air-conditioning unit cannot be switched on again until 3 minutes have elapsed. To confirm, a small star symbol is being displayed. If the request to switch on the system is made earlier, it is registered (big star symbol) and then executed automatically after the 3 minutes have passed.

Exception In case the unit has been switched off via the coin-box system, it may be switched on again immediately.

Body fan

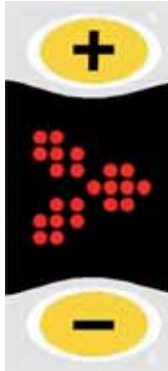

The power of the body fan can be increased or reduced step-wise (by 10 % each) by touching the „+“ or „-“ fields. The initial value after turning on the unit is set to 30%. When changing the value, the current setting is displayed as a two-digit number between „20“ (minimum) and „99“ (maximum) in the numerical field for a short time. In order to switch off the body fan completely, press the „-“ field several times until the value of 20% appears. After that press the „-“ key once again and keep it pressed for 0.5 sec. After a time lag the body fan is eventually switched off. The body fan can be switched on again at any time simply by touching the „+“ field.

Facial tanner

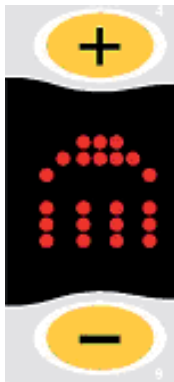

Level II Once the tanning program has been started, the tanners are automatically switched on at maximum setting.

Level I To reduce the output to level I, use the „-“ field. This step is not available with megaSun 4000 Super, Super Power and Ultra Power UV type 3.

Level 0 To switch off the facial tanners completely, touch the „-“ field again for at least 3 seconds. Touching the „+“ key, you can switch the facial tanners on again, or increase their power. After having switched the facial tanners off, there is a time lag (depends of its temperature) before they may be turned on again.

„Spaghetti“ tubes in XXL tanning beds: Touching the „-“ key, you can switch off every second „Spaghetti“ tubes in the facial area. (Switch on by touching „+“ key) Touching the „-“ key again, you can switch off the rest of the „Spaghetti“ tubes in the tanning bed. (Switch on by touching „+“ key).

aroma with clock relay



The option „aroma“ is controlled by a clock relay.

$T_{on} = 12\text{ s}$

$T_{off} = 60\text{ s}$

The time adjustment will be done at the relay (see pict. at the left hand side).

On the upper counter, the scope is set for T_{on} , here 6 .. 60 s.

With the potentiometer below the factor is set here 2.

So you get the time for $T_{on} = 6\text{ s} * 2 = 12\text{ s}$.

Accordingly the time is set for T_{off} : The scope T_{off} is 6...60 s too, the factor is set to 10.

So you get the time for $T_{off} = 6\text{ s} * 10 = 60\text{ s}$.

During time T_{on} the compressor is on and air is blown through the aroma box. The fragrance comes out at the foot of the bed. The air stream leads the fragrance over the body to the face so that it can be perceived intensively.

The relay is mounted on a plate at the left foot in the front.

The client cannot switch off or on the aroma function by the display.

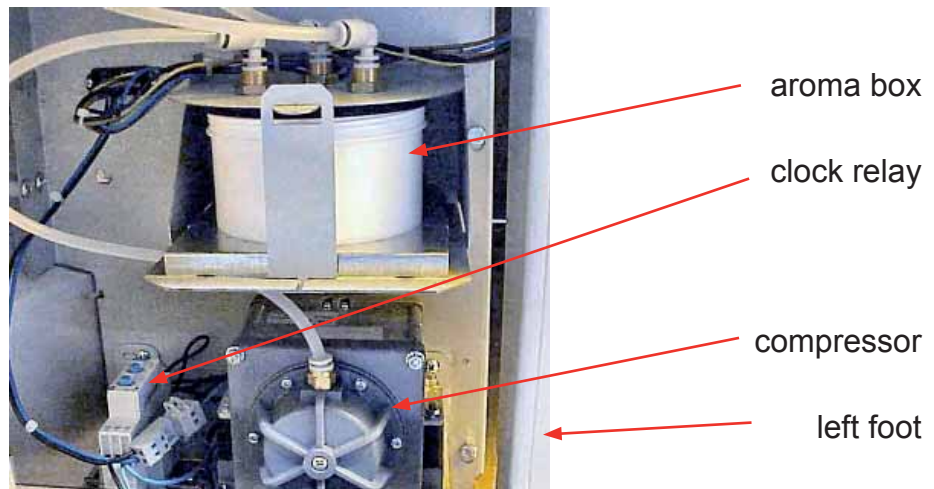

If the aroma box is empty, lift the top and open it. Replace the empty box with a new one and close the top.

10

Submenu P = Program



The submenu P = program exists when equipped with internal and external music. The client can choose between readyly configured music sources wellness, pop or external music (studio system). While toggling through the channels, the chosen one is displayed for a short time.

3. Maintenance of the unit

Preparatory works



Before opening the unit, switch off the fuses to disconnect it from the mains supply! Never operate the tanning unit without the bulkhead plates, acrylic panes or with the bed section opened, for otherwise the tanner areas will become overheated. This will destroy the filter panes!

3.1. Cleaning and care

Plastic parts

The major plastic parts consist of solid high-grade ABS material.

Note

The surfaces and the acrylic panes must not be cleaned with concentrated disinfectants or solvents or other liquids that contain alcohol! The manufacturer cannot be held liable for any damage caused by chemically active agents such as unsuitable cleaning agents. To clean the varnished or plastic surfaces, use a damp soapy cloth. Make sure that there is no cleaning fluid running inside the appliance. This has to be avoided at any rate!

Acrylic panes

Unsuitable cleaning or disinfecting agents may damage the surface of the acrylic panes (base pane) and further materials, particularly if there are drops of perspiration in addition to that.

„megaClean“

The cleaning and disinfecting agent “megaClean“, to be purchased from KBL, has specifically been developed for use on acrylic surfaces and is regarded as safe. It is diluted in water at a ratio of 1:13.

Chromed parts

Clean only with a damp (not wet) washleather and a plexiglass cleaner (antistatic). The cleaning agent must be applied onto the cleaning cloth and not directly onto the chromed parts.

3.2. Dismantling the acrylic panes

Dismantling the pane in canopy

The acrylic panes of both the canopy and the bed are held in place by means of aluminium profiles. Two pan-head screws secure the base pane.

Step	Procedure	Reference
1	Open the system by lifting up the canopy.	
2	Turn the right-hand / left-hand lock (with 8 mm hexagon socket) carefully to the right / left and swing the front swivel hinge profile downwards. If necessary, pull a little bit in the middle. Once the canopy pane may be moved, tilt it downwards and place it on the bed section (arrange for padding).	Fig. 3-1 Fig. 3-2
3	When the pane is in the lower position, you can lift it out of the swivel hinge profile, if necessary. For cleaning the pane, this is not required	Fig. 3-3
4	Mount the panes in reverse order. Ensure that the pane is correctly positioned in the hinge. Relock the swivel hinge profile.	

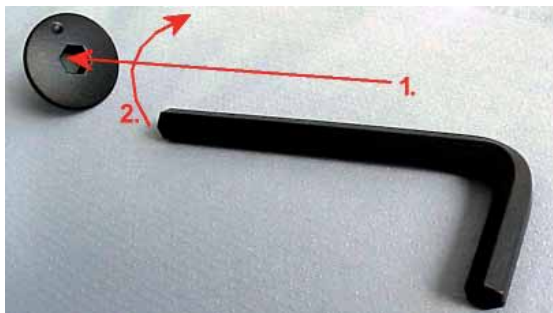

Fig. 3-1 Opening the front swivel hinge profile using a hexagon recess wrench (Allen key) of 8 mms (1 and 2)



Fig. 3-2 Turning the profile (3).



Fig. 3-3 Rear pane profile

Base pane and ducting pane

The following table describes the cleaning of the base pane and the ducting pane.

The electronic parts installed underneath the bed must not get in contact with any moisture. Therefore, in order to clean the underside of the base pane and the inner base section, use a slightly damp cloth only.

Step	Procedure	Reference
1	Open the system by lifting up the canopy.	
2	Undo the two pan-head screws on the right-hand and on the left-hand side of the base pane	Fig. 3-4
3	Pull the base pane out of the rear hinge profile. Put the pane in a safe place.	
4	Clean the underside of the base pane.	
5	In case there is a ducting pane in the base section (for tanning systems equipped with air-conditioning unit), it can be lifted out for cleaning purposes.	
6	Re-insert the base pane, clean its upper surface and fasten the base pane by means of the two screws. Hint: Lift the base pane a little bit when mounting.	



Fig. 3-4 Undo the two screws of the base pane

3.3. Filter panes

Safety function The facial tanners are equipped with an additional safety function. Behind each of the filter panes, there is a safety cutout switch that will switch off the burner in the case of a missing or broken pane.

Never operate the tanning system with a defective filter pane.

Carry out visual inspections regularly!

Filter panes may only be replaced by ones of the same type!

The filter panes may be dismantled and replaced by trained expert staff only.

Filter panes After having dismantled the frame carrying the filter pane (see below), clean the filter pane with a household glass cleaning agent and a soft cloth or chamois leather.

Filter pane in the frame

Step	Procedure	Reference
1	Dismantle the acrylic pane of the canopy.	see 3.2
2	Undo the screw fixing the filter pane frame (1), swing the frame downwards (2) and pull out the frame including the filter pane (3).	Fig. 3-5 Fig. 3-6
3	After cleaning, mount the filter pane again by following the reverse order.	



Figure 3-5 Cover of the filter frame

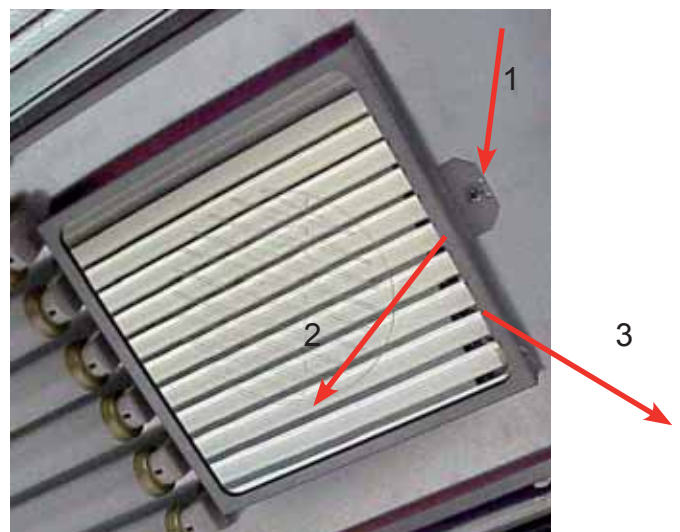

Figure 3-6 Remove the filter frame

Filter panes with clamping springs

Step	Procedure	Reference
1	Undo the screw fastening the filter pane covering (1). Swinging the covering towards yourself (2) and pull it out (3).	Fig. 3-7
2	Press carefully the filter pane downwards using both hands (4) until the pane is released by the upper springs (5). Take the filter pane out of the clamping springs that retain it.	Fig. 3-8
3	After cleaning (use any household glass-cleaning agent) mount the filter pane again.	



Abb. 3-7 Filter pane covering



Abb. 3-8 Clamping springs retaining the filter panes

3.4. Tubes and facial tanners

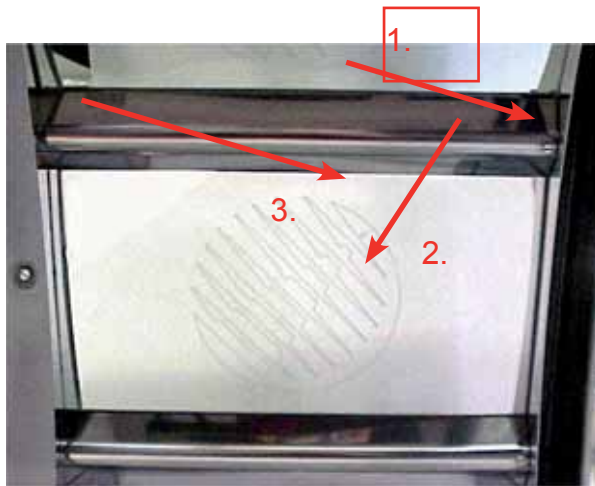
Dismantling In order to be able to clean or replace the tubes or the facial tanners, please carry out the procedure described below:

Step	Procedure	Reference
1	Dismantle the canopy pane and the base pane	Section 3.2
2	For units equipped with burners: You will have to remove the filter panes for access to the burners in case you need to replace them.	Section 3.3
3	When installing the tubes, make sure that the inscription is visible, which means that the reflector is at the rear side.	
4	When replacing the tubes, remember to install new starters!	

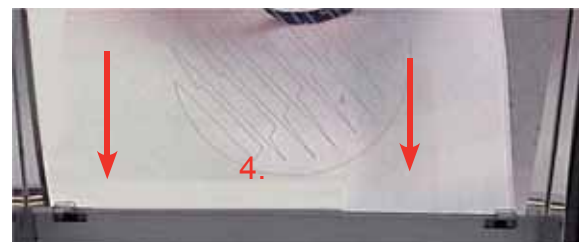
To make sure that the tanning effect is maintained, we recommend cleaning the tubes and UV burners with warm water and a chamois leather after approx. every 200 hours of operation. Do not use any aggressive or alcoholic cleaning agents.

Unit lighting The coloured filter (Sec. 5.7 Unit lighting) has to be replaced at the latest when replacing the tanning tubes.

Tubes, facial tanners and starters may only be replaced by ones of the same type! When installing the tubes, make sure that the inscription is visible, which means that the reflector of the tube is at the rear side.

For units equipped with CPI technology, it is vital to carry out a reset after each tube replacement! see

For units operated with inductive technology, also install new starters with each tube replacement. Remember to set the working hours counter to zero. (see 6.1)

All units with burners	Inductive units	CPI units			
		with facial tanners		without facial tanners	
Burner	Tubes and starters	Mode			
		Eco	Power	Eco	Power
500 - 600 hrs	500 – 600 hrs	800 hrs	500 hrs	1000 hrs	800 hrs
Zero setting - see section 6.1		Carry out a reset! See section 7.1			

3.5. Removing the burners

The burners may be installed or removed by trained expert staff only.

Step	Procedure	Reference
1	Remove the canopy pane and the filter pane frame.	Section 3.2 and 3.3
2	Hold the burners with a soft cloth, then push them to one side and pull them out towards the front.	Fig. 3-9 and Fig. 3-10
3	You must not touch the burner glass with your bare hands. If necessary, clean the bulb with an alcohol-containing cleaning agent..	

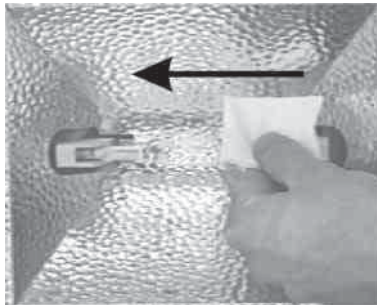

Figure 3-9 Pushing the burner towards the side

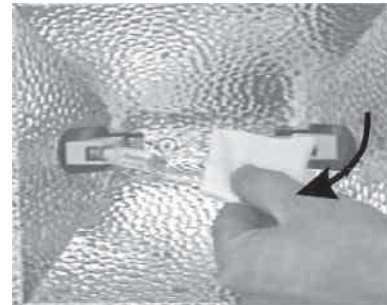

Figure 3-10 Pulling the burner out towards the front

Installing the burners

Dirt accumulation and incorrect positioning may result in damage to lamps and sockets when the system is running. Therefore, on inserting the burners, you must ensure that the contact surfaces of both sockets and burners are clean. Insert the burners straight into their sockets. After being inserted into the socket, the little metal shackle in the centre of the reflector should face the reflector.



Abb. 3-11 Burner KBL 3230 355 00

3.6. Unit lighting

Coloured filter The coloured filter has to be replaced at the latest when replacing the tanning tubes.

Replacing the lighting system in the lateral part and in the base part One tube (8 watts) each is installed in the side frames (see Figure 3-6-2), another tube (58 watts) is installed in the lower front section (see Figure 3-6-3) and in the canopy's front there are two 42 W compact fluorescent lamps.

Step	Procedure	Reference
1	<i>Side frames:</i> Undo the screw fixing the interior lateral panel. Remove the panel and the coloured tube covering. Now you may replace both tube and starter.	Fig. 3-6-1 and Fig. 3-6-2
2	Re-install all parts in reverse order.	
3	<i>Bench:</i> The lighting tube is installed behind the front profile and may be easily exchanged. The starter is located at the left-hand socket.	
4	<i>Canopy</i> <ul style="list-style-type: none"> Take off one of the chromed faceplate which is fastened with hook and loop tape. Unscrew the the mounting plate's four screws and remove the mounting plate. Pull out the illuminant carefully. While replacing it, see that the connector is in the correct position. Attach the mounting plate. See that the edge of the dispersion plate is beneath the mounting plate. Attach the chromed faceplate. Repeat the procedure on the other side. 	Fig. 3-6-4 Fig. 3-6-5 Fig. 3-6-6 Fig. 3-6-7

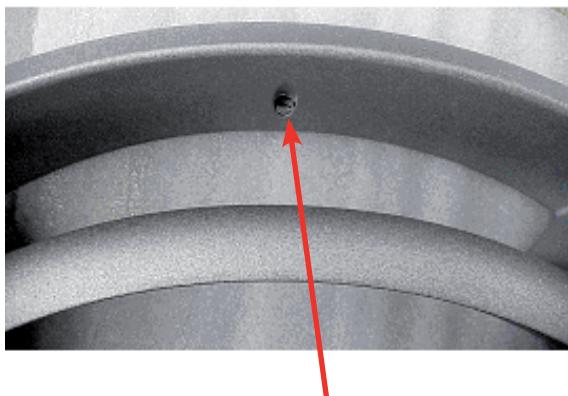

Fig. 3-6-1 Fixing screw at the interior lateral covering

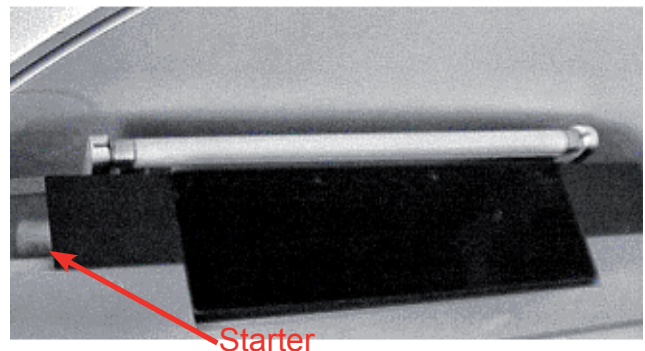

Fig. 3-6-2 Lighting tube in the lateral part, including starter



Fig. 3-6-3 Unit lighting in the lower base section, the starter at the left hand side



Fig. 3-6-4 Chromed faceplate



Fig. 3-6-5 Mounting plate



Fig. 3-6-6 Mounting plate removed



Fig. 3-6-7 Correct position of the connector

3.7. Canopy drive

Regular maintenance In order to ensure a trouble-free operation of the drive, check and service it each time the tubes are replaced (see table below). If the canopy does not remain safely in the upper position any more, the spring must be re-tensioned.

Tension the spring While tensioning or relaxing the spring, fix it against torsion.

Step	Procedure	Reference
1	Check the spring rope for wear. Should individual wires of the rope be spliced, replace the rope.	
2	Lubricate the rope in the return-pulley area by using HHS 2000 spray lubricant.	Fig. 3-16
3	Tension the spring in such a way that the canopy remains stable in any position. The spring-compressor is kept below the bed, at the front left-hand side	Fig. 3-15
4	The rope has to be replaced after 3,000 hours of use: <ul style="list-style-type: none"> - Completely relax the spring. - Remove the upper covering of the attachment fitting of the rope. - Undo the bolt and remove the used rope, paying attention to the position of the bolt. - Hinge the lubricated new rope, fix the bolt and tension the spring. 	Fig. 3-17 Fig. 3-18 spray lubricant HHS 2000
5	Test the canopy drive: If it is working properly, you can easily open and close the canopy, and it remains stable when in its upper position.	



Figure 3-15 Spring compressor The spring has to be secured against torsion while tensioning and relaxing.



Figure 3-16 Return pulley



Figure 3-17 Upper rope covering

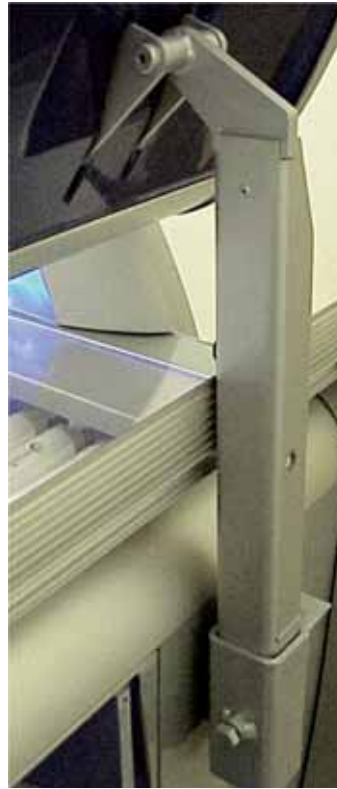

Figure 3-18 Canopy suspension, right-hand side and left-hand side

3.8. Filter mats

Cleaning interval The cooling air is drawn in through two dust filters. Depending on the installation site, clean the filter mats or, if necessary, replace them after approx. every 100 hours of use. To ensure trouble-free operation of the unit, exclusively use original spare filter mats.

Whenever you clean or replace the filter mats, also check the heat exchangers of the air-conditioning unit for traces of dirt. (section 3.10). Dirty heat exchangers considerably reduce the capacity of the air-conditioning unit. Vacuum-clean the heat exchangers, if necessary.

Filter mats in the canopy and in the base section The filter mats are located behind the grip edge of the canopy, or behind the front profile of the base section respectively. They may easily be replaced.

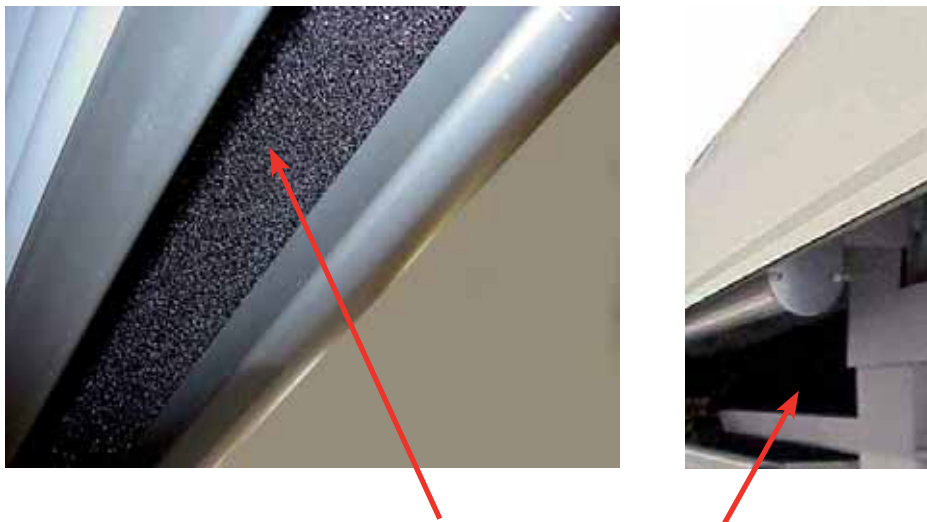

Figure 3-19 Filter mats in the canopy and in the base section

3.9. Cooling and exhaust air

Unit cooling: The air for cooling the tubes and burners in the canopy section is sucked in through the upper filter mat. Ambient air for cooling the tubes in the base section is sucked in through the front filter mat in the base section. The fan collects the cooling air coming from above and below, which is then blown off through the exhaust-air flue.

Body cooling: A body fan blows ambient air (if not equipped with air-conditioning unit), or chilled air (if equipped with air-conditioning unit), into the tanning space of the system (blue). The air spoiler at the canopy pane directs this air towards the face.

Cooling of the base pane

If the system is equipped with an air-conditioning unit (optionally available), the base pane is also cooled. The ambient air is sucked in through the filter, chilled in the air-conditioning unit and led through an air hose to the space between ducting pane and base pane. At the foot end of the base section the air is blown into the tanning space of the system.

Maintenance of the exhaust-air system and the air-conditioning unit

A clean exhaust air system in good working order prevents the unit from overheating. The maximum length of the exhaust-air hose of 6 metres must not be exceeded if there is no additional fan.

Step	Procedure	Reference
1	Open the lower front cover and check the following items regularly:	
2	Check the air-conditioning unit and the condensate pump.	see section 3.10
3	The air hoses at the rear wall must not be kinked.	Figure 3-21
4	The filter mats in the base section and in the canopy must be clean.	see also section 3.8
5	Check whether the exhaust-air hose is kinked or damaged; furthermore, check the working order of the additional fan in cases where the hose length exceeds 6 m.	
6	Adequate ventilation and air extraction both in the studio and in the tanning booth must be ensured at all times.	

3.10. Air-conditioning unit

air hose leading to bed

outward condensate hose,
guiding the condensate
into a tank

condensate pump

condensate pan

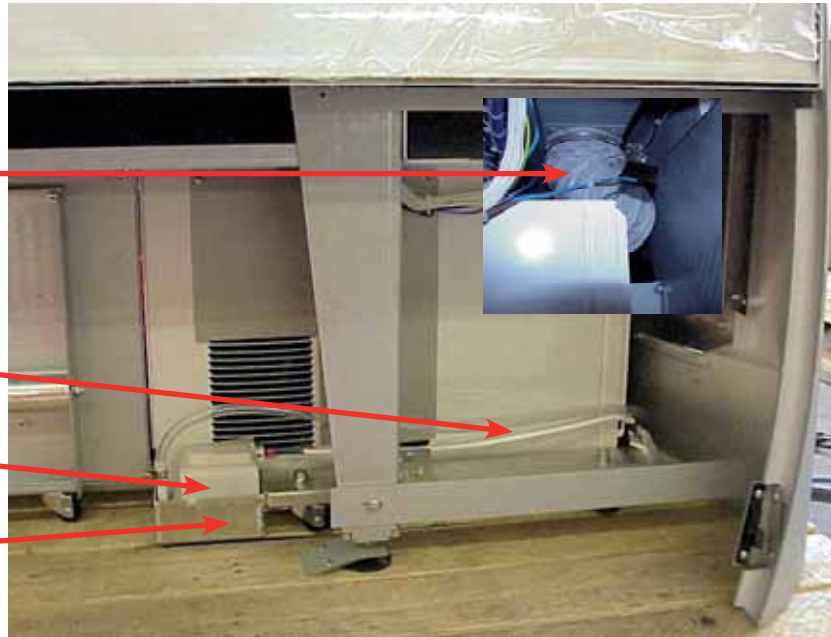

Check routine

Check the heat exchangers of the air-conditioning unit for dirt particles each time a tube is replaced. Dirty heat exchangers reduce the capacity of the air-conditioning unit. Open the lateral cover and vacuum-clean the heat exchangers, if necessary. Check the connection hose each time the tubes are replaced. Defective hoses must be replaced.

3.11. Condensate pump

Function The condensate pump is controlled by the processor in such a way that, during the tanning session, it is switched on every 5 minutes for 20 seconds () each. After the tanning session is over, this sequence is repeated 3 times.

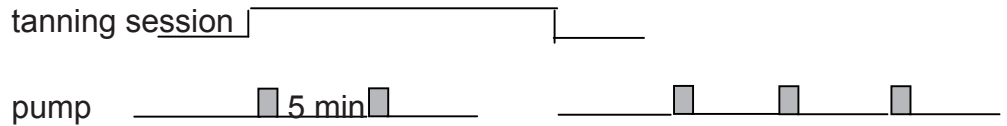

Maintenance Check the function of the condensate pump each time a tube is replaced.
 Open the front cover and slowly fill the condensate pan in the air-conditioning unit with water.
 Ensure that the water is pumped out when the pan is around half full. For this check, the mains voltage must be connected.
By servicing the unit regularly and properly you substantially contribute to a long period of trouble-free and safe operation.
 The condensate hose must be guided into the condensate tank without being kinked. The maximum height of the hose must not exceed 25 cm from the bottom level of the tanning system.



Figure 3-25 Condensate outlet at the rear right-hand side

4. Technical data

4.1. Data that is common to all unit models

A notice board bearing the following wording must be permanently fixed at the cubicle wall near the tanning unit:

Warning: UV radiation may cause damage to eyes and skin. Ask the operating staff for further information. Wear protective goggles. Certain medicaments or cosmetics may increase the sensitivity. (UV type of the unit)

Ambiant conditions

Installation site	in dry rooms with sufficient air supply and ventilation
Relative air humidity	<70 %
Ambient temperature	<30°C (86°F)
ATTENTION!	The unit must not be operated in case the coin-box timer system or the internal monitoring of the maximum tanning time is faulty or if a filter broken or missing.

Condensate

Water outlet	in dry rooms with sufficient air supply and ventilation
Disposal	connection to sewage system or tank (capacity ≥ 5 litres)
Quantity	depends on the local conditions and the air humidity
Note!	As the condensate has to be pumped out, the power supply must not be disconnected, not even after the tanning session.

Electrical connection

Mains voltage	400 V / 3N / 50 Hz
Fuses	3-pole slow-blow fuse protection; further details available with the technical data of the respective model
Cable cross section	5 x 2.5 mm ² Oilflex
Internal plug socket	for PCs, lamps, or similar items; NOT to connect welding equipment, angle grinders or similar devices

Dimensions megaSun 4500

Central exhaust-air duct and exhaust air hose	Ø 300 mm
Quantity of exhaust air	2000 m ³ /h
Weight ind. (w. A/C)	480 (530) kg
Weight CPI (w. A/C)	450 (500) kg

4.2. Views

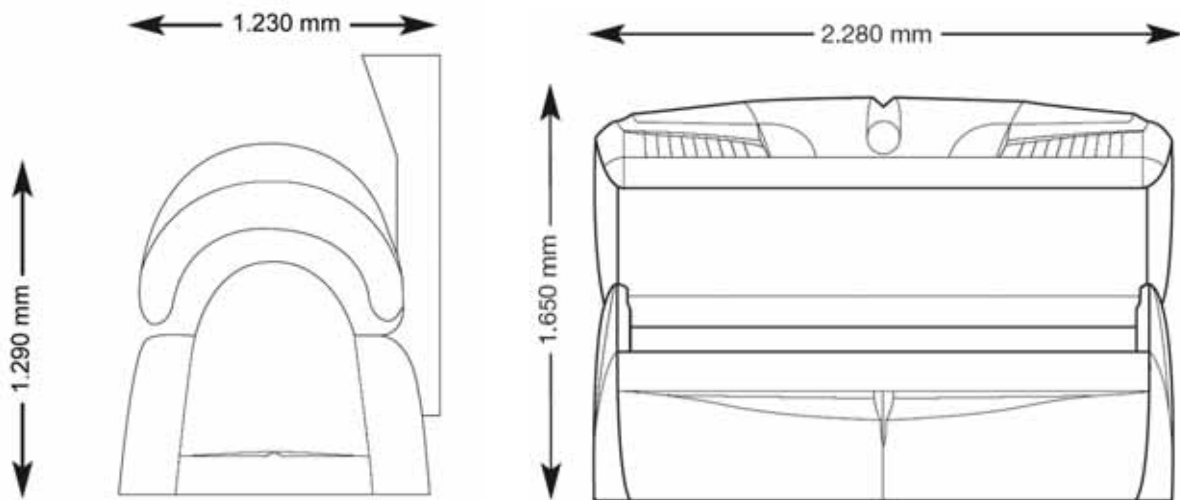

Figure 4-1: side and front view

4.3. megaSun 4500 Super

	inductive	CPI
Lamps	megaSun 300 / 500 KBL 3230355000	
pcs / power	3 x 300 W	
Filter panes	T324, coated	
Tubes	pcs / type	
Canopy	24 / megaSun Super R 100 W	
Bench	16 / megaSun Super R 100 W	
Rated capacity W		
w. air-conditioner	6890	7890
w/o air conditioner	5930	6930
Fuse	3-pole slow-blow fuse protection, 3 x 16 A	

4.4. megaSun 4500 Super Power

	inductive	CPI
Lamps	megaSun 300 / 500 KBL 3230355000	
pcs / power	3 x 400 W	
Filter panes	T324, coated	
Tubes	pcs / type	
Canopy	24 / megaSun Super R 160 W	24 / megaSun Ultra Power R 160 W Longlife
Bench	16 / megaSun Super R 120 W	
Rated capacity W		
w. air-conditioner	8630	9630
w/o air conditioner	7670	8670
Fuse	3-pole slow-blow fuse protection, 3 x 16 A	

4.5. megaSun 4500 Ultra Power

	inductive	CPI
Lamps	megaSun 300 / 500 KBL 3230355000	
pcs / power	3 x 400 W	
Filter panes	T324, coated	
Tubes	pcs / type	
Canopy	24 / megaSun Super R 160 W	24 / megaSun Ultra Power R 160 W Longlife
Bench	16 / megaSun Super R 160 W	16 / megaSun Ultra Power R 160 W Longlife
Rated capacity W		
w. air-conditioner	9590	10590
w/o air conditioner	8630	9630
Fuse	3-pole slow-blow fuse protection, 3 x 16 A	
w. air-conditioner	3 x 20	
w/o air conditioner	3 x 16	3 x 20

4.6. megaSun 4500 XXL Super Spaghetti

Tubes	pcs / type
Canopy	21 / megaSun XXL Super R 120 W 30 / megaSun Super R Pink 25 W
Bench	16 / megaSun Super R 100 W
Rated capacity W	
w. air-conditioner	7115
w/o air conditioner	6155
Fuse	3-pole slow-blow fuse protection, 3 x 16 A

4.7. megaSun 4500 XXL Super Power Spaghetti

Tubes	pcs / type
Canopy	21 / megaSun XXL Super R 180 W 30 / megaSun Super R Pink 25 W
Bench	16 / megaSun Super R 100 W
Rated capacity W	
w. air-conditioner	8690
w/o air conditioner	7730
Fuse	3-pole slow-blow fuse protection, 3 x 16 A

4.8. megaSun 4500 XXL Ultra Power Spaghetti

Tubes	pcs / type
Canopy	21 / megaSun XXL Super R 180 W 30 / megaSun Super R Pink 25 W
Bed	16 / megaSun Super R 160 W
Rated capacity W	
w. air-conditioner	9650
w/o air conditioner	8690
Fuse	3-pole slow-blow fuse protection
w. air-conditioner	3 x 16 A
w/o air conditioner	3 x 20 A

5. Wiring diagrams

5.1. Mains voltage

Fuses and residual current-operated circuit breaker (FI)

The unit has to be connected to the 400 V mains; fuses protect the connection. For details on the fuses, please refer to the section „Technical data“. An FI protective switch (residual current-operated circuit breaker) is required in any case. KBL recommend the following type: KBL 3200 077000.

Should any interference occur due to the operation of your tanning unit with the mains, e.g. with ripple-control systems (TRA), consult your power-supply company regarding the installation of corresponding blocking elements (audio frequency suppressor).

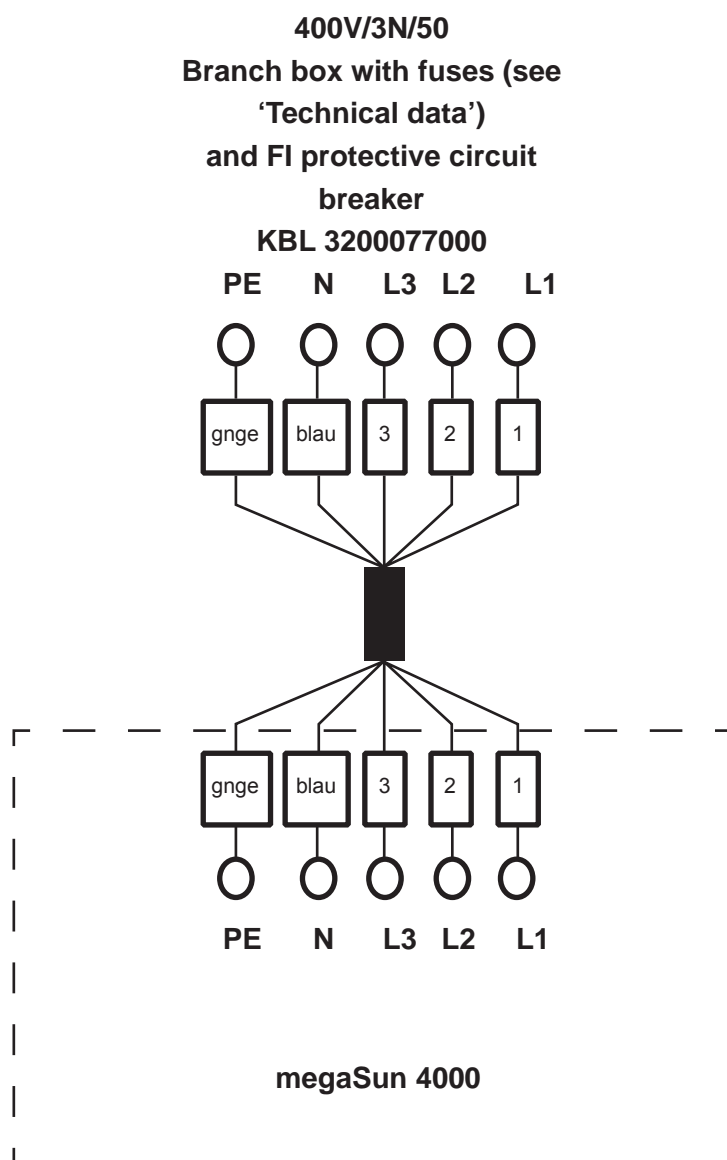

5.2. External audio signal

Audio amplifier

KBL 3220 285000

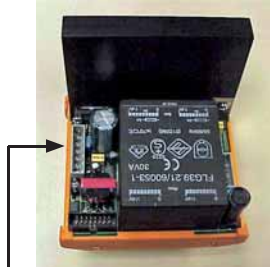

Terminal E8

The audio signal is connected to the amplifier by means of a 2-pole shielded cable. At the source of the signal, the shield is connected to ground. The cable is connected to terminals E8:1 and E8:2 of the audio amplifier.

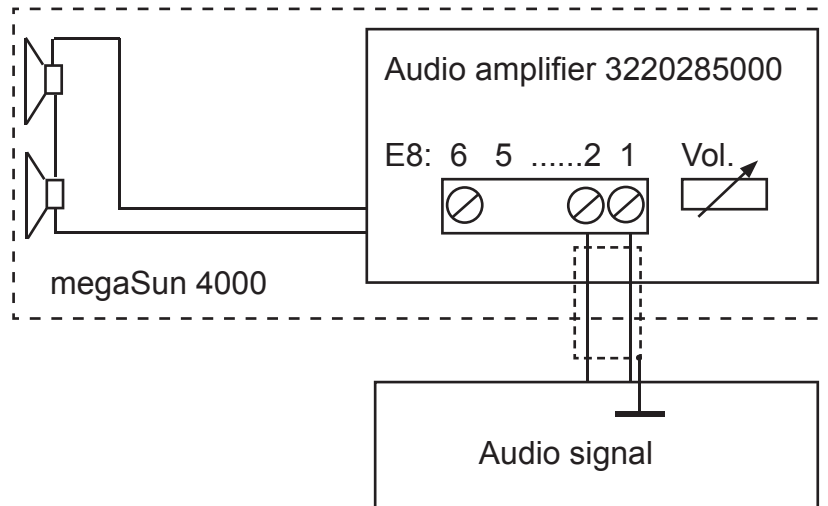

100 V audio signal

Transformer

KBL 9100 0170 00



For this application, a transformer 91000170 is required. The audio signal is connected at the terminals „IN“

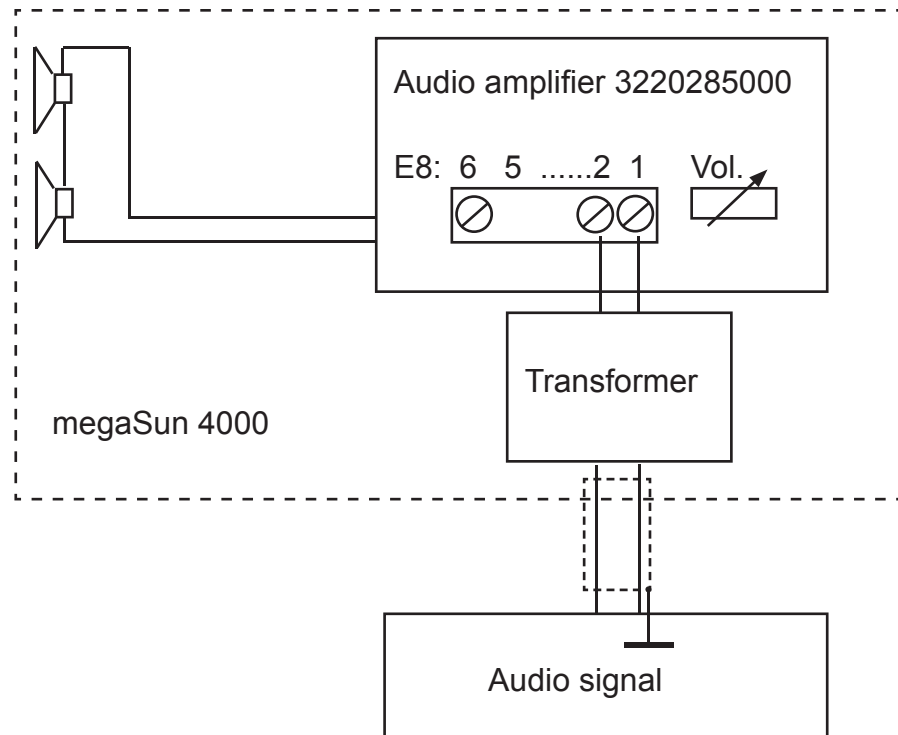

5.3 Music Preselection

Preselection

The function P (=program) allows it to choose one out of three music sources - provided that they are configured in the service menu.

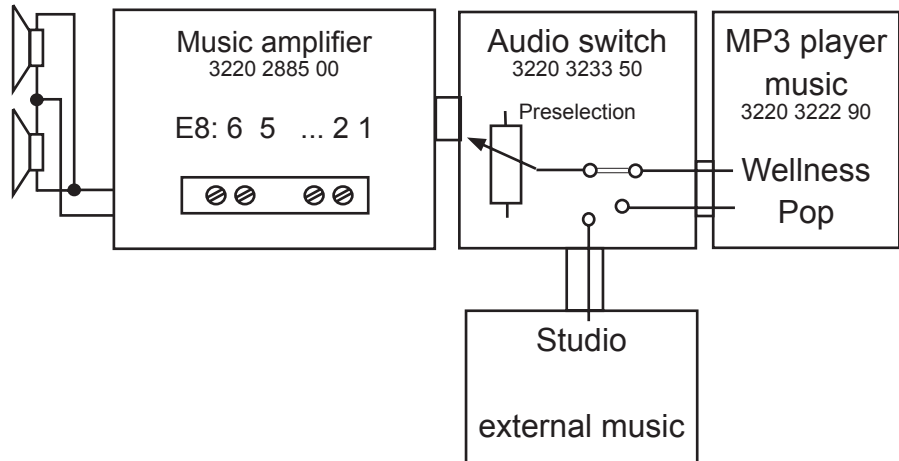

musicVibration

Instead of the loud speakers - as seen above - you can use musicVibration with active subwoofer and two tweeters. The function P in Preselection is a software feature.

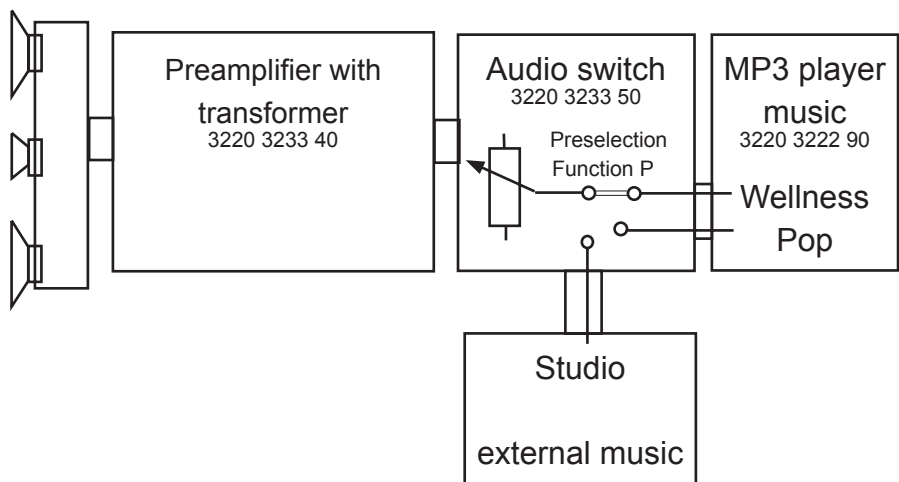

5.4 External Timer

The figure shows the connection principle of a timer. Please note the specifications and wiring diagrams applicable for the individual types.

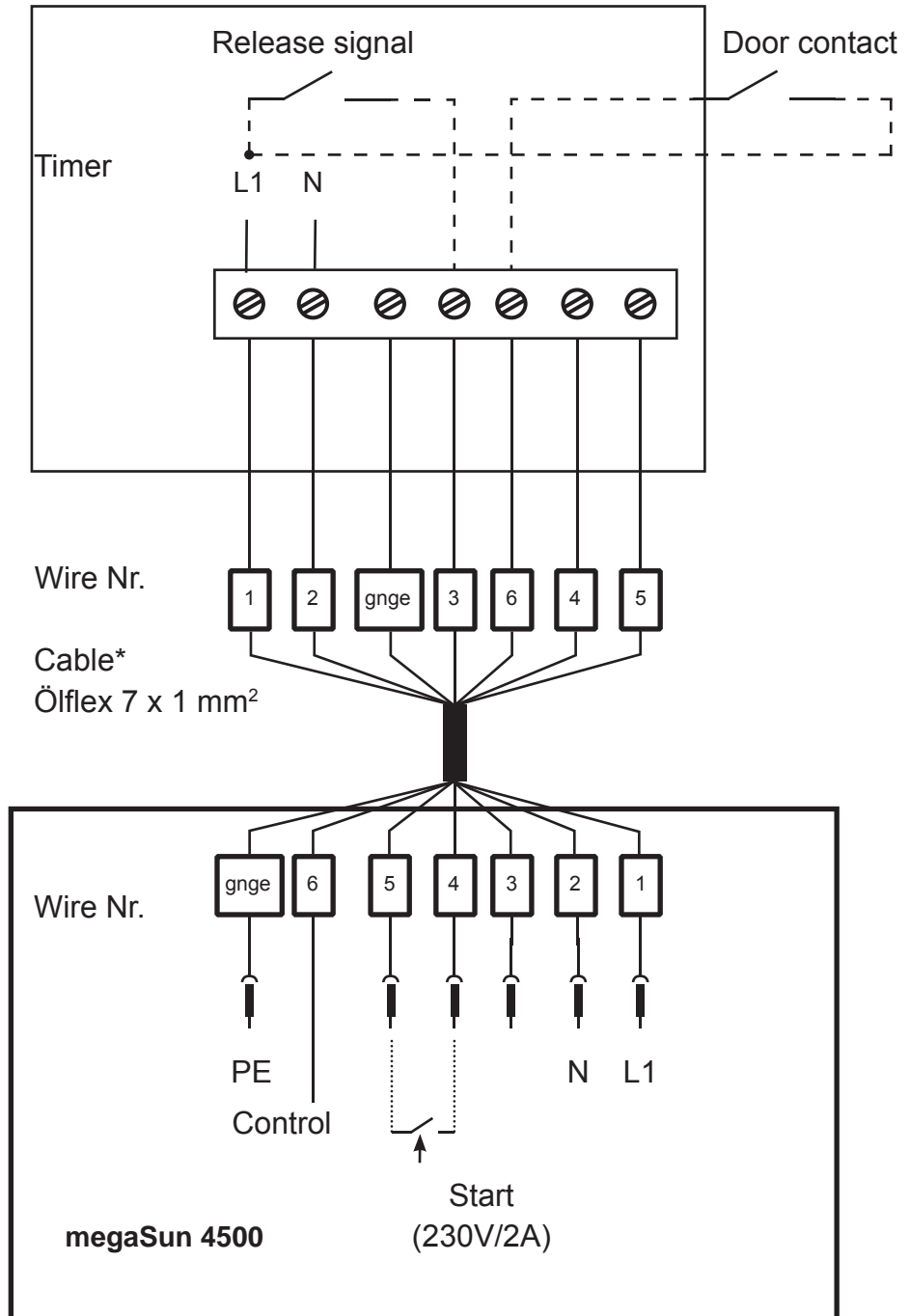

* supplied by KBL

6. Service mode - inductive

Differences	The inductive controlled sunbeds are equipped with the KBL processor /5 and the CPI controlled devices with the KBL processor /4. The processor /4 used a serial interface for software download. All functions (see chapter 7) are available in this sunbed.
Service levels	<p>There are two service levels that are both protected by passwords. In order to access these levels and to trigger any processes, the touch keys 1 ... 0 have to be pressed. Therefore the plus and minus keys bear numbers adjunct to them; the numbers you see in the illustration below are slightly bigger than they are in reality. In order to get access to the service pages, two prerequisites have to be fulfilled:</p> <ul style="list-style-type: none"> — there must not be any error message on the display — there must not be any incoming signal from the coin/token box system. <p>In case there is an error message pending you need to reset this message by touching the „Stop“ sensor field.</p>

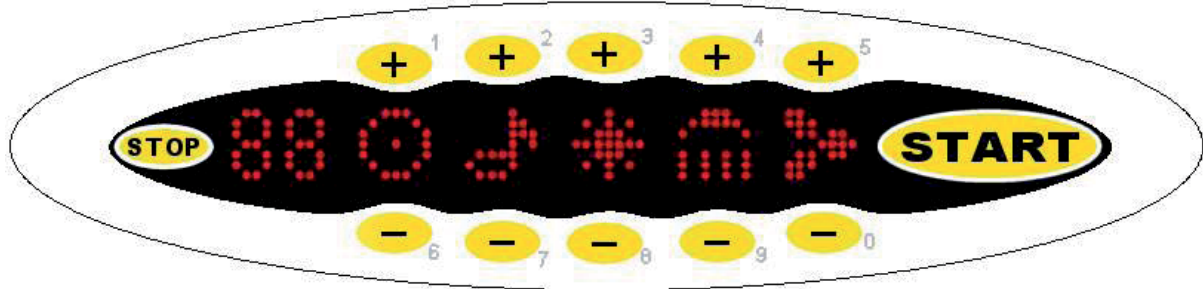

Figure 6-1 Touch keys 1 ... 0 for service operations

Service level I	To access service level I, first enter the sequence 1 6 1, and then enter the PIN 1 1 1 1.
Service level II	This level comprises service pages that may exclusively be used by Technical Service staff. Service level II is accessed from the level I menu "PIN II" by entering the correct PIN.
Leaving the service level	You may leave both levels by pressing START. Any changes made will be taken over and saved.
Menus available on the service levels	The menus available on the respective service level are entered by pressing the touch keys 5 (forward) and 0 (back).

6.1. Service level I - inductive

Menus

The following menus are available on service level I; they may be entered by keys 5 (forward) and 0 (back):

- Unit operating hours
- PIN II
- Reset working hours of tubes
- Working hours of tubes

Indication of operating hours



PIN II

Entering PIN to access service level II



Triggering for the channel selection

Here, the triggering for the channel selection can be set: either BCD or PULS.



Reset of working hours of tubes

After a tube replacement the working hours counter is reset by pressing the key 1.

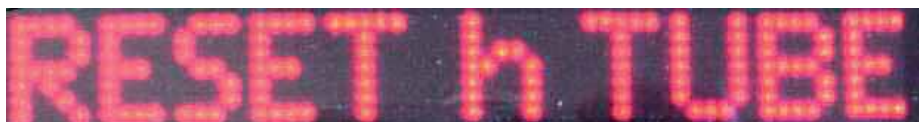

Indication of working hours of tubes



6.2. Service level II - inductive

Configure options

C M A B



Service level II offers you the following menu:

— C M A B

This menu serves to switch on or off certain functions. This feature is useful in case a function is missing or temporarily unavailable (masked).

- C Channel / music channel
- M Music / volume
- A Air conditioner / air-conditioning unit
- B Facial burner / facial tanner

The setting may be changed by pressing the “+“ or “-“ keys above and below the respective symbol.

If the colon is located at the lower side of the letter, the corresponding function is not available.

7. Service Mode CPI

The inductive controlled sunbeds are equipped with the KBL processor /5 and the CPI controlled devices with the KBL processor /4. Also, inductive controlled sunbeds with more features than external music are equipped with the KBL processor /4. The processor /4 used a serial interface for software download. All functions (see chapter 7) are available in this sunbed.

7.1. General information and structure

Service levels

There are two service levels which are both accessible by passwords. To get into these levels and to release processes the touch keys 1 ... 0 have to be pressed. For that purpose, the plus and minus keys bear numbers which in the illustration below are slightly bigger than in reality. In order to get access to the service pages, two prerequisites have to be fulfilled

- there must not be any error messages on the display
- there must not be any incoming signal from the coin/token box system

In case there is an error message you need to reset this message by touching the „Stop“ sensor field.

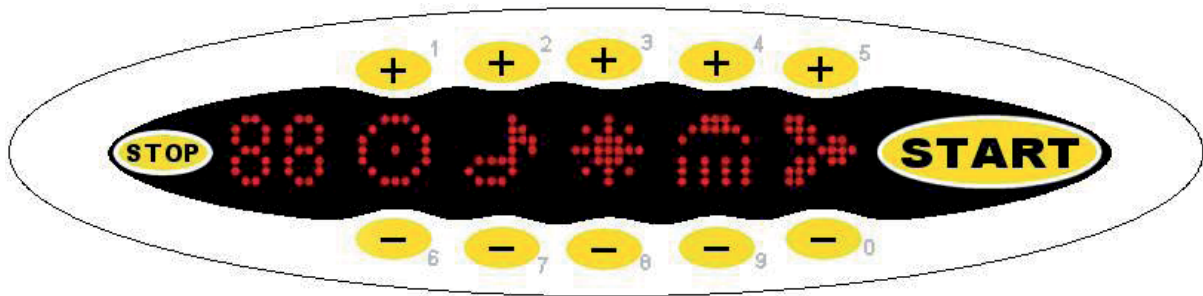

Illustr. 7-1 Touch keys 1 ... 0 for service operations

Service level I	In order to get access to level I, first enter the sequence 1 6 1 and then PIN 1 1 1 1.
Service level II	This level comprises service pages that may be used by technical service staff only. Starting from level I, menu „PIN II“, you will get into level II by entering the correct PIN (not 1 1 1 1!)
General navigation	<p>When having called up service level I, the following keys can be used as follows:</p> <p>Key 5 — to move forward in the menu</p> <p>Key 0 — to move backwards in the menu</p> <p>Stop key — to leave service level or menu</p> <p>Start key — to select a menu item or to save the value displayed</p>

Service level I

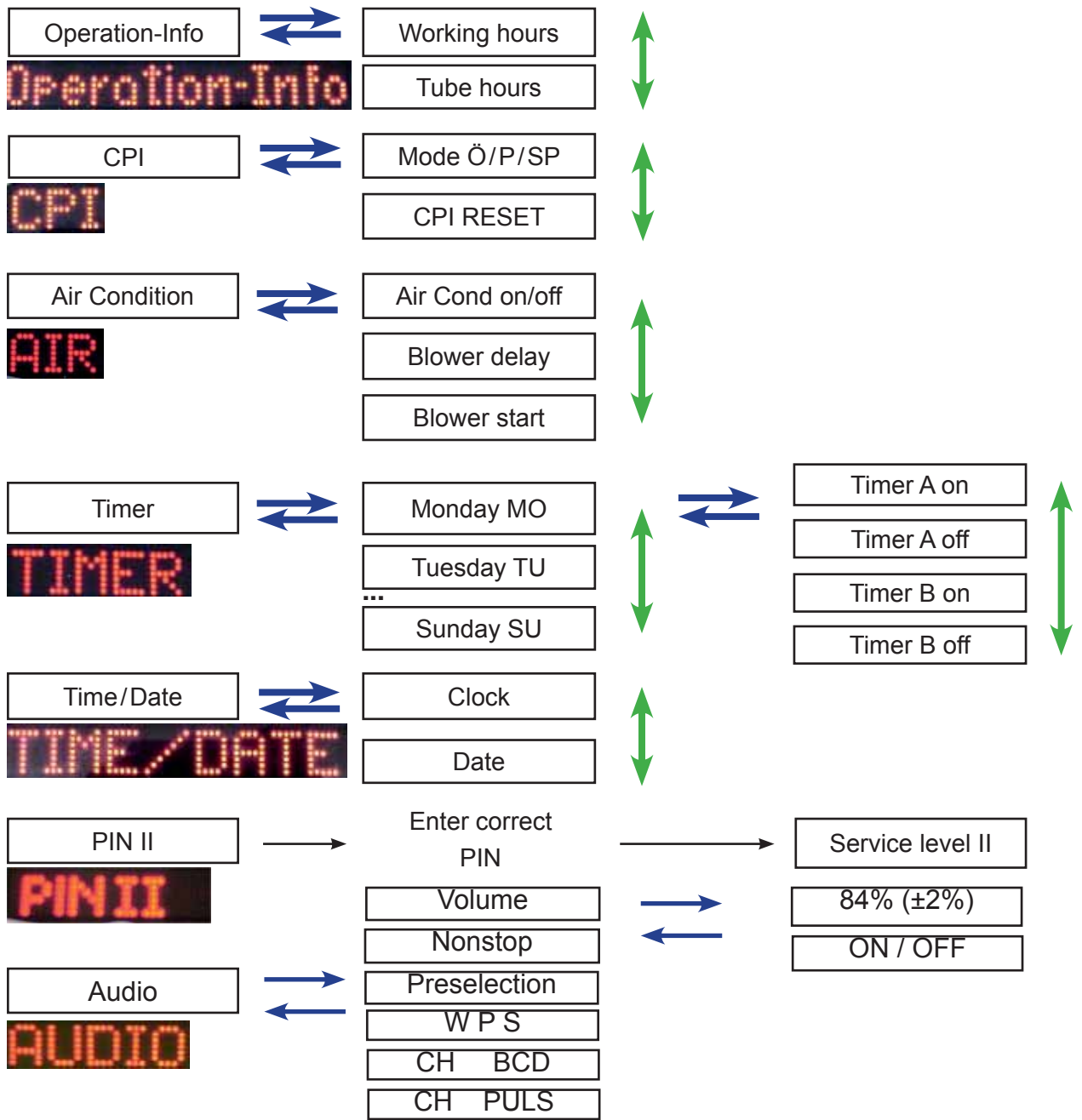

Service level II

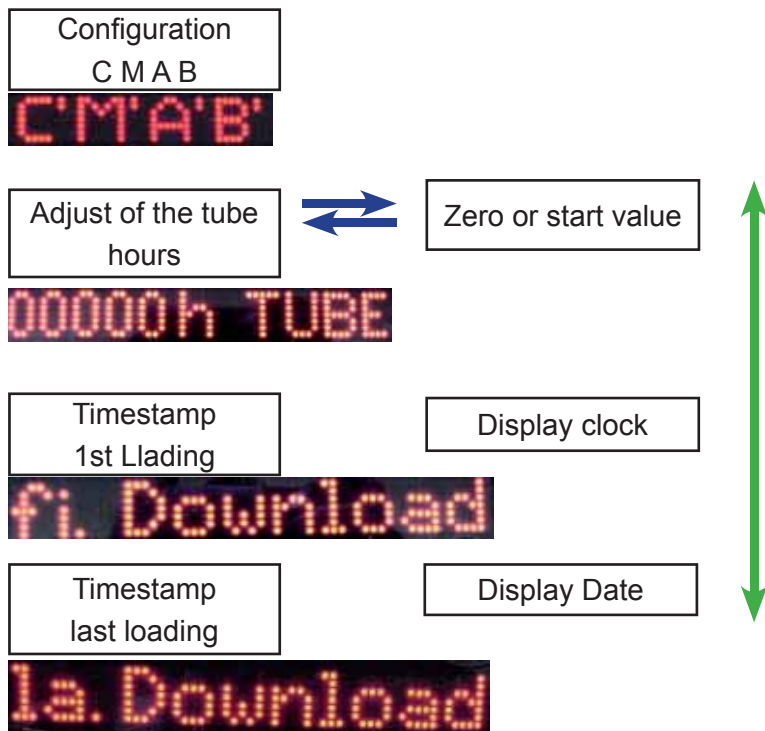

7.3. Service level I - CPI

Operation info In this menu, the service hours of the sunbed (WORK) and the burning time of the tubes (TUBE) are displayed.

	START	Display	Selection
Operation-Info	→ ←	00146h WORK	5
	STOP	00000h TUBE	0



You open this menu using START (here OPERATION-INFO). You go back to the next higher level menu using STOP (here OPERATION-INFO).

CPI The different CPI-modes are displayed which can be adopted or reset (RESET).

	START	CPI Modes	Selection	Confirmation
CPI	→ ←	MOD: OKO	4	START
	STOP	MOD: POWER		START
		MOD: SUPER P.	9	START

	CPI Reset	Selection	Confirmation
	MOD: POWER	0	
	CPI RESET POW	5	1

Air-conditioning Ventilator

This menu offers the following possibilities:

- The air-conditioning system can be switched on or off. When the software has been loaded it is in the ON position. In this menu, it can be switched off or on.
- When the software has been loaded the speed of the body fan is set at xx%. In this menu, it can be adjusted to values between 0-99 % in steps of 10% at the beginning of the tanning session. Here in this menu a value of 50% has been pre-set. It is also possible to switch the fan off
- The time lag of the body fan can be set in steps of 5 seconds, with each new start this interval will be accepted.
- The setting is saved and is then available for the next start.

			Selection
AIR	START	Aircon. OFF / Aircon. ON	0
		A.AFTER 015s.	
	STOP	A.START 50%	5

		Auswahl	Speichern
Air conditioner ON / OFF	Aircon. ON	9	START
	Aircon. OFF	4	START
Time lag of the fan	A.AFTER 015s.	9	START
		4	
Initial revolution of the fan	A.START 50%	9	START
		4	

Timer

This function allows you to specify two times for switching on and two times for switching off the decorative lighting for any day of the week. If you do not need the switching time you can delete it by pressing key 1. The hours are set using keys 2 – 4 and the minutes by pressing keys 3 – 8.

		Weekday: Monday ... Sunday	Selection	Confirmat.
TIMER	START	MO	0	START
			
	STOP	SU	5	

Switching time A/BON und A/BOF	Hrs / Min	Store
MO ---:--- BON	2 3	START
MO ---:--- BOF	4 8	START

Time / Date

This menu shows time and date. Both values can be changed.

		Display Date	Selection
TIME/DATE	START	08:37 @	5
		30.01.03 TH	0
	STOP		

Change the time	Selection	Store
08:37 @	Hrs. Min 1 3 6 8	START
Change the date	Day	Store
30.01.03 TH	1 6	START

The day of the week appears automatically.

PIN II	START	Enter PIN II and in service level II the menu CMAB opens.
	STOP	

Audio

This menu has the following sub-menus:

- EXTERN: If the signal is ON, an external source sends the music signal, otherwise the internal MP3-player is used.
- VOL. HOT: the volume of the music or of the user guidance system when the fan is running
- VOL. COOL: the volume of the music or of the user guidance system when the fan is not running.
- NONSTOP: when the signal is ON, the music signal is permanently amplified, otherwise the music transmission ends with the tanning cycle.
- CH: The channel selection may be changed from channel and volume selection to BCD selection of a music source. It is possible to select up to 4 music sources. (The volume is adjusted at the music amplifier).
- PRESELECTION shows which music sources are set by the studio operator.
- WPS: Selection of the music sources Wellness, Pop and Studio.

The menu can be selected by pressing the „0“ and „5“ keys, the functions can be activated or inactivated by pressing the „+“ key above OFF or the „-“ key below ON, or you can increase or decrease the values by pressing +/- above the numerical value.

			on / off	Confirm.
AUDIO	START	EXTERN OFF	+ / -	START
	← →	VOL.HOT 88%	Adjust + / -	in 2-%-Steps
	STOP	VOL.COOL 58%	Adjust + / -	in 2-%-Steps
		NONSTOP ON	on / off + / -	
		CH PULS	5 ↑ Select	Confirm.
		CH BCD	0 ↓	START
		PRESEL. S		Confirm.
		W.P.S	on / off + / -	START

W Wellness music
P Pop music
S Music from
studio control
system

First, you set the active configuration in the menu W P S. The „+“ keys above W, P or S stand for the option „on“. You can activate all three sources at once if they are physically available. To deactivate an option press the „-“ key. Press **START** to save the new setting.

In the table, the studio operator has selected only S which means, the music is provided by the studio's audio system. Selected options in the WPS menu have superior points (S[•]). If you select two or three items, e.g. W[•] P[•] S[•], the studio operator can preselect which source is selected after the start of the tanning program. Press the „+“ key (4) or the „-“ key (9). The appropriate character (W, P or S) is shown in the PRESEL. menu.

During the tanning program, the client can toggle between these sources. He opens the first submenu by pressing the „+“ key above or the „-“ key below the „P“. The newly selected music source (Wellness, Pop or Studio) is displayed for a short time. The channel selection symbol stands for „next title“ with Wellness and Pop and for „next external music channel“ with Studio (see also service level II for the configuration the external channels in menu „C M A B“). Use +“ key for forward and „-“ key for backward.

7.4. Service level II - CPI

Overview

This level contains the following menus:



Selection of the menus by pressing the keys 0 or 5

Configuration menu



In this menu functions can be activated or inactivated. This makes sense when the corresponding function is missing or temporarily not available (faded out).

C Channel / Music channel

M Music / Volume

A Air-conditioning

B Facial tanner The setting can be changed by pressing the "+" or "-" key above or below the symbol. If the two dots behind the letter are at the bottom, the respective function is inactivated.

C: no channel selection possible

B: facial tanner can be operated

Tube hours

In this menu, you can set the service hours of the tubes in steps of 5 hours. This display has to be reset to zero after each tube replacement.

Attention! Always carry out a reset after each tube replacement!

		Change	Store
START	00000h TUBE	1	START
		6	
STOP			

Time stamps

Here you can store the time stamps of the first and last download of the software.

the menus by pressing the

			Selection
			5
First Download			
			0
			Selection
			5
Last Download			
			0

7.5. Error messages

**Error messages
“exhaust air“ or
“air-flow switch“**

The cause of the error message has to be removed by service staff.

Reasons for these error messages appearing are:

- no free exhaust-air flow in the hose or
- this error message is displayed on the operating panel and may be acknowledged by pressing the “Stop“ touch key.

**Error messages
“temperature too
high“ or “thermal
switch“**

The cause of the error message has to be removed by service staff. Reasons for these error messages appearing are:

- insufficient cooling of the unit or
- dirty filter mats This error message is displayed on the operating panel and may be acknowledged by pressing the “Stop“ touch key.

**Error message
“End of tanning
session“**

This message will be displayed after 40 minutes of uninterrupted operation of the tanning system. By turning off the coin-operated system this message is acknowledged.

8. Tanning instructions

8.1. General tanning instructions

	Note
1	The various skin types can tolerate exposure to sun and the duration of tanning sessions to different extents. Use the skin type table and the respective tanning program as guidelines. Once you have reached your final tan, further tanning can only be achieved by considerably exceeding the recommended tanning times. This is to be avoided at all costs!!
2	UV radiation emitted by the sun or UV appliances may cause damage to skin or eyes. These biological effects depend upon the quality and quantity of the radiation as well as the skin and eye sensitivity of the individual.
3	The skin may develop sunburn after an excessive exposure. Excessively repeated exposure to UV radiation from the sun or UV appliances may lead to premature ageing of the skin as well as increased risk of the development of skin cancer.
4	The unprotected eye may develop surface inflammation, or in some cases, e.g. after a cataract operation, damage may occur to the retina after excessive exposure. Cataracts may form after many repeated exposures.
5	Special care is required in case of pronounced individual sensitivity to UV radiation and in cases where certain medicines or cosmetics are used.
6	It is not to be taken as a general fact that exposure to UV radiation in tanning systems reduces the risk of suffering sunburn in any individual case.
7	The unit must not be operated if the timer or filter pane(s) are defective.
8	The following safety precautions must be taken — Always use the goggles provided. — Remove any cosmetics well in advance of exposure and do not use any type of sunscreen. — Do not undergo exposure when taking medicines which increase sensitivity to UV radiation. If in doubt, take medical advice. — Allow at least 48 hours between the first two exposures; do not sunbathe and use the tanning system on the same day. — Follow the recommendations concerning exposure durations and intervals — Seek medical advice if persistent lumps or sores develop, or if pigmented moles change in appearance.
9	People belonging to one of the following groups must not use this tanning unit: — children — individuals with heart pacemakers — persons burning without tanning when exposed to the sun — persons suffering from sunburn — persons suffering from, or having suffered from, skin cancer, or individuals with a predisposition to skin cancer.
10	UV type 4 tanning systems: Warning – To be used only after consulting a doctor.

8.2. megaSun 4500 Super, ind. / CPI, UV type 3

Tanning session	Skin type II	Skin type III Time in min	Skin type IV
1	6	6	6
2	7	8	8
3	8	9	10
4	9	11	12
5	9	12	15
6	10	13	16
7	11	15	18
8	12	16	20
9	13	18	22
10	14	19	24
11	15	21	26
12	16	22	28

The interval between two tanning sessions must be at least 48 hours.

Max. number of tanning sessions per year @ 15 kJ/m ²	60	43	33
-----------------------------------------------------------------	----	----	----

8.3. megaSun 4500 Super Power, UV type 4

Tanning session	Skin type II	Skin type III Time in min	Skin type IV
1	4	4	4
2	4	4	5
3	5	5	6
4	5	6	7
5	5	7	8
6	6	8	9
7	6	9	10
8	7	9	12
9	7	10	13
10	8	11	14
11	8	12	15
12	9	13	16

The interval between two tanning sessions must be at least 48 hours.

Max. number of tanning sessions per year @ 15 kJ/m ²	60	43	33
-----------------------------------------------------------------	----	----	----

8.4. megaSun 4500 Super Power, ind. / CPI, UV type 3

Tanning session	Skin type II	Skin type III Time in min	Skin type IV
1	5	5	5
2	6	7	7
3	7	8	8
4	7	9	10
5	8	10	12
6	9	11	14
7	9	12	15
8	10	14	17
9	11	15	18
10	12	16	20
11	12	17	22
12	13	18	24

The interval between two tanning sessions must be at least 48 hours.

Max. number of tanning sessions per year @ 15 kJ/m ²	60	43	33
-----------------------------------------------------------------	----	----	----

8.5. megaSun 4500 Ultra Power, UV type 4

Tanning session	Skin type II	Skin type III Time in min	Skin type IV
1	4	4	4
2	4	4	5
3	5	5	6
4	5	6	7
5	5	7	8
6	6	8	9
7	6	9	10
8	7	9	12
9	7	10	13
10	8	11	14
11	8	12	15
12	9	13	16

The interval between two tanning sessions must be at least 48 hours.

Max. number of tanning sessions per year @ 15 kJ/m ²	60	43	33
-----------------------------------------------------------------	----	----	----

8.6. megaSun 4500 Ultra Power, ind. / CPI, UV type 3

Tanning session	Skin type II	Skin type III Time in min	Skin type IV
1	5	5	5
2	6	7	7
3	7	8	8
4	7	9	10
5	8	10	12
6	9	11	14
7	9	12	15
8	10	14	17
9	11	15	18
10	12	16	20
11	12	17	22
12	13	18	24

The interval between two tanning sessions must be at least 48 hours.

Max. number of tanning sessions per year @ 15 kJ/m ²	60	43	33
-----------------------------------------------------------------	----	----	----

8.7. megaSun 4500 XXL Super Spaghetti, UV type 4

Tanning session	Skin type II	Skin type III Time in min	Skin type IV
1	5	5	5
2	6	7	7
3	7	8	9
4	8	9	10
5	8	10	13
6	9	12	14
7	10	13	16
8	10	14	17
9	11	15	18
10	12	17	21
11	13	18	23
12	14	19	25

The interval between two tanning sessions must be at least 48 hours.

Max. number of tanning sessions per year @ 15 kJ/m ²	60	43	33
-----------------------------------------------------------------	----	----	----

8.8. megaSun 4500 XXL Super Power Spaghetti, UV type 4

Tanning session	Skin type II	Skin type III Time in min	Skin type IV
1	5	5	5
2	6	6	7
3	7	8	8
4	7	9	10
5	8	10	12
6	9	11	14
7	9	12	15
8	10	14	17
9	11	15	18
10	12	16	50
11	12	17	22
12	13	18	24

The interval between two tanning sessions must be at least 48 hours.

Max. number of tanning sessions per year @ 15 kJ/m ²	60	43	33
-----------------------------------------------------------------	----	----	----

8.9 megaSun 4500 XXL Ultra Power Spaghetti, UV type 4

Tanning session	Skin type II	Skin type III Time in min	Skin type IV
1	5	5	5
2	6	6	7
3	7	8	8
4	7	9	10
5	8	10	12
6	9	11	14
7	9	12	15
8	10	14	17
9	11	15	18
10	12	16	50
11	12	17	22
12	13	18	24

The interval between two tanning sessions must be at least 48 hours.

Max. number of tanning sessions per year @ 15 kJ/m ²	60	43	33
-----------------------------------------------------------------	----	----	----

9. Index

Symbole		
100 V audio signal	31	
A		
Air-conditioning unit	24	
Air-conditioning Ventilator	41	41
Air conditioner	41	
Anschlussdiagramm		
Externer Timer	33	
aroma	10	
Audio	43	
Audio amplifier	31	
B		
Base pane and ducting pane		13
Body fan	9	
C		
Canopy drive	20	
Cleaning		
Acrylic panes	11	
Condensate pump	25	
Configuration menu	45	
Cooling	23	
D		
Dismantling the panes		11
E		
Exhaust air	23	
External Timer	33	
Externer Timer	33	
F		
Facial tanner	9	
Facial tanners	16	
Filter mats		
Cleaning	22	
Filter panes	14	
I		
Installing the burners		17
M		
Mains voltage		30
Menus		
inductive	34	
O		
Operation	6	
R		
Running time		
Operation menu	7	
S		
Safety information	5	
Service level II - inductive		36
Service levels		
CPI	36	
Service levels		
inductive	34	
Service level II - CPI		45
Service level I - CPI	40	
Service level I - inductive		35
T		
Tanning instruction	47	
Technical data	26	
Timer	41	
Time stamps	46	
Tubes	16	
Tube hours	45	
U		
Unit lighting	18	
V		
Views	27	