

Technical Data

Length	2240 mm / 88"	
Breadth	1250 mm / 50"	
Height	1320 mm (closed); 1680 mm (opened) / 52" - 66"	
Weight	750 kg	
Division of lamps		
Canopy	27 x low pressure lamps	160 Watts
	4 x Dr. Kern High Pressure Lamp	400 Watts
Bench	19 x low pressure lamps	160 Watts
	6 x low pressure lamps	25 Watts
Total Output	12500 Watts	
	1-phase	3-phase
Rated current	60 amps	3 x 40 amps
Fuse protection	70 amps	3 x 50 amps
Power cord	3 x AWG 4	4 x AWG 6



ASSEMBLY AND USER'S MANUAL FOR SOLARIUM VIVA 4

Guarantee / Registration card

Irrespective of the dealer's obligations under his sale agreement, the guarantee period for sunbeds (radiation sources excepted) is one year from date of purchase. In the case of commercial use e.g. in hotels or guest-houses, the guarantee period is six month from purchase.

Within these time limits, we shall rectify, free of charge, damage demonstrably attributable to defects of material or workmanship.

Damage caused by misoperation or improper use does not come under the guarantee. Any transport costs incurred in the dispatch or return of equipment cannot be accepted by us.

In the event of complaint, please send this guarantee slip - together with the sale invoice in all cases - to the dealer, after-sales service centre, or direct to the manufacturer.

Date of purchase:

Dealer:



Warranty

With the exception of acrylic sheets, starters and lamps and filter glass, this solarium is warranted for (1) one year on all factory components or parts, and 30 days on labor after initial installation. Repairs that are required as a result of damage during transportation to the end-user's location, as well as any due to neglect, improper installation, or handling, are not covered.

Important note: This warranty must be activated prior to installation of the unit. To activate the warranty, please fill out the accompanying product registration card and mail it to us. or, call **1-800-908-9885** and register your solarium. Make sure to have your model and serial number before calling.

Service Address:
DR. KERN GMBH
D-35759 Driedorf / Germany
Phone: (0 49 27 75) 8 22 40
Fax (0 49 27 75) 8 24 55
e-mail: servicecenter@dr-kern.de
Internet: <http://www.dr-kern.de>



Druck Nr. 29491927 / 49.01 20011895



Table of Contents

Important notices	3
Important things to know before tanning	3
Tanning	
Instructions on tanning	4
Exposure schedule	4
Exposure distance	4
For commercial operators	4
After tanning	5
Instructions for Use	
Electrical requirements	5
Primary timer	5
System operation and control	6
Console features	6
Feature description	6
Recommendations for Exhaust System Placement	
Outside temperature	7
Air-inlet vents	7
Cabin ventilation	7
Exhaust hose placement and hose diameter	7
Maintenance	
Replacing the lamps and starters	8
UV lamp and starter replacement in the solarium bench	8
UV lamp and starter replacement in the shoulder tanner	9
Lamp replacement in the decorative lighting unit	9
UV lamp and starter replacement in the canopy	9
UV lamp and starter replacement in the lamp segment/pedestal	11
Metal halogen lamp replacement in the high-intensity facial tanners	11
Removal of the filter plates	12
Canopy unit lift system	12
Cleaning the solarium	12
Replacing the filter mats	13
Filter mat replacement in the air-conditioning unit	13
Disassembling the solarium before installation	
Pane frame pedestal	14
Ergo - acrylic bench plate	14
Bench unit	14
Lamp frame pedestal	15
High-pressure lamp unit socket	15
Acrylic frame canopy	16
Lamp frame canopy	16
Fan unit / bench in the pedestal	17
Pedestal cover panel	17
Air-intake, pedestal	18
Air conditioner	19
Ballast units / compensator	19
Hot air recycling / exhaust shaft	19
Canopy	20
Central fan	21
Back wall	22
Base plate	22
Assembly unit, air conditioner	22
Frame rack	23
Electrical connections	
Connecting to the main power supply	24
Remote control	24
Fan-on delay	24
Connecting time-control units / coin boxes with remote start capability	25
Connecting a low-voltage time-control unit	25
Interconnection of the electrical components	25
Indications	
General guidance on repair and replacement of parts	27
Notice concerning "air flow switch"	27
Technical Data	
Guarantee / Registration card, Warranty	28

Indications

General guidance on repair and replacement of parts

Make sure the terminal and cabling placement correspond exactly. When making a change in the configuration of the cabling, the danger arises that lines may become overloaded or wire current carrying capacities are no longer adequate.

In addition, the phase symmetry can be adversely affected, causing fuses to blow.

The electrical power for the system is distributed to three phase leads as follows:

- L1: lamps in the bench unit, all ventilators and controls, decorative appliances
- L2: lamps in the canopy L1-L18, air conditioning unit
- L3: lamps in the canopy L19-L20, lamps 21-27 in the lateral frame and high-pressure tanner.

Use only manufacturer-approved replacement parts.

Notice concerning "air flow switch"

The system is equipped with a ventilator for the central exhaust system. Should this ventilator break down, there is considerable risk of the equipment overheating and causing a fire.

For this reason, the exhaust system has an air flow switch which interrupts the power supply to the UV lamps after about 2 minutes after failure of the central ventilator.

The air flow switch is mounted on the side of the exhaust shaft and may not be bypassed.

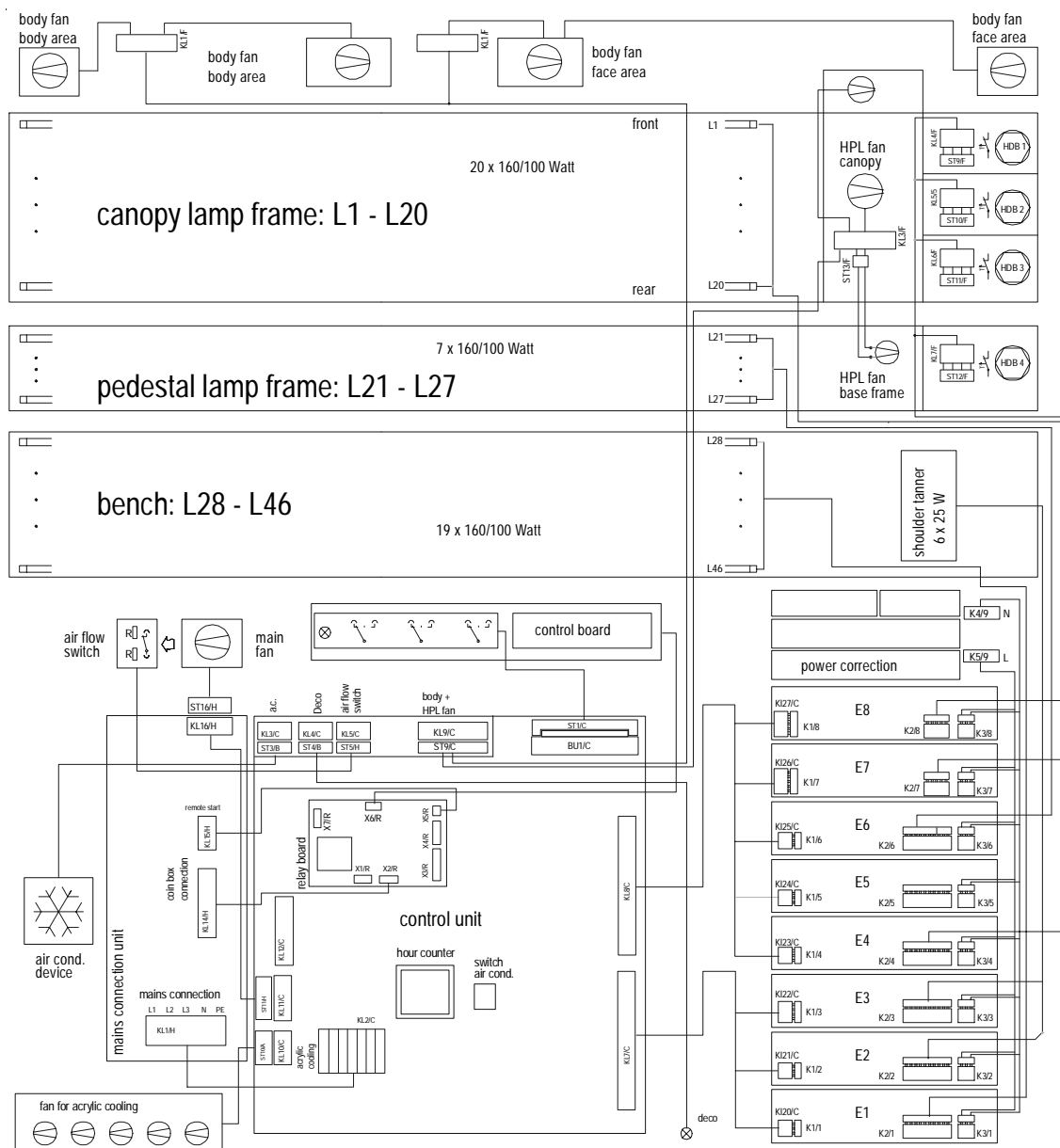
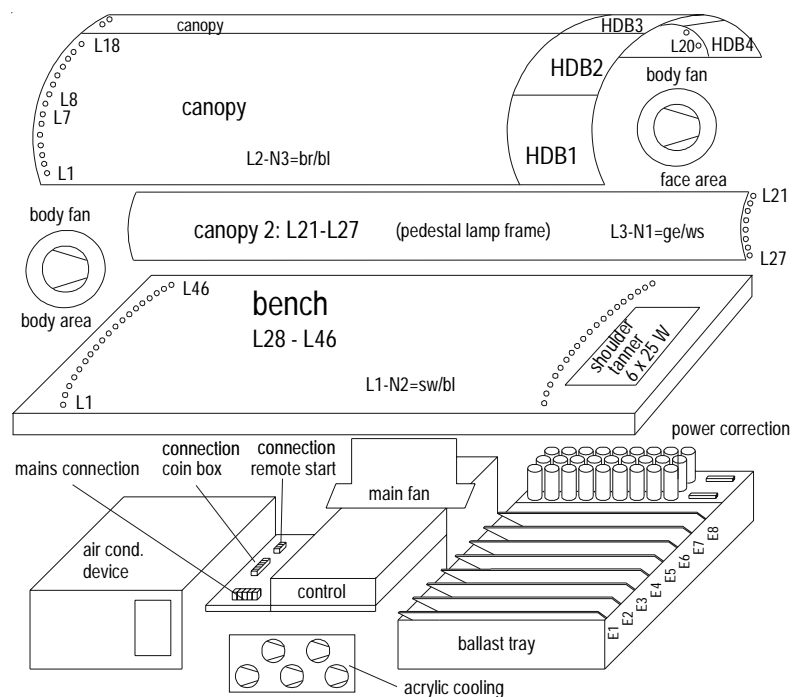

WARNING:

- Read the instruction booklet before using this product.
- When using a folding combination machine with bench and canopy, lie down on the bench and pull the canopy down until it will move no further. When using a canopy only, lie down and pull the canopy down as far as the stand will allow.
- Operation of this device closer to the body than the recommended minimum distance for use may result in overexposure.
- Recommended eyewear: Provided eyeshields (Intrexco Nr. 5635/1s) or equivalent eyewear as defined under 21 CFR 1040.20 2(b) (6).

One pair of protective eyewear is furnished with this equipment and should be worn by all persons in the room when lamps are on. Disconnect power cord before attempting to clean, replace lamps or engage in the maintenance of this product. THE FOLLOWING LAMPS HAVE BEEN CERTIFIED FOR USE IN THIS EQUIPMENT: **COSMEDICO VHR 160 W, COSMEDICO UVA plus 25 W, DR. KERN 400 W HP-Lamp** or compatible types. THIS PRODUCT CONFORMS WITH PERFORMANCE STANDARDS FOR SUN LAMP PRODUCTS UNDER 21 CFR PART 1040.20

DANGER

Ultraviolet radiation. Follow instructions. Avoid overexposure. As with natural sunlight, overexposure can cause eye and skin injury and allergic reactions. Repeated exposure may cause premature aging of the skin and skin cancer. WEAR PROTECTIVE EYEWEAR; FAILURE TO MAY RESULT IN SEVERE BURNS OR LONG-TERM INJURY TO THE EYES.

Medication or cosmetics may increase your sensitivity to the ultraviolet radiation. Consult physician before using sunlamp if you are using medications or have a history of skin problems or believe yourself especially sensitive to sunlight. If you do not tan in the sun, you are unlikely to tan from the use of this product. Minimum use distance is 1 inch or 2.54 centimeter. Tanning may appear after one application provided that your skin is capable of developing a suntan. Allow 48 hours between sessions to obtain a base tan, once or twice per week to maintain appearance.

Important notices

- The solarium is designed for connection to a 220 V single or 220 V 3-phase. Only a power cord 3 x AWG 4 SJT (1-phase) or 3 x AWG 6 (3-phase) with a maximum length of 25 ft may be used.
- This solarium may only be used in a dry area, free of liquid spray or high humidity (below 70 %). The ambient temperature should not exceed 28 degrees Celsius (85 Degrees Fahrenheit), otherwise the surface temperature of the bench may become warm.
- To prevent overheating of the solarium, air intake vents and fan output areas must not be blocked.
- In the event of a ventilation fan failure, the solarium will operate warmer than normal, and should be shut down immediately to repair or replace the fan.
- Insure that the solarium is disconnected from the main power source when replacing lamps, starters, or acrylics, as well as during maintenance or cleaning.
- Electrical reparation may only be conducted by an authorized technician.
- The floor surface upon which the solarium is to be placed must have a support rating of at least 150 Lb. per square foot. If the surface rating cannot be officially confirmed, Dr. Kern USA must be contacted for further instructions prior to installation.

- The acrylic shields are not compatible with certain types of cosmetics and cleaning agents on the market. Compatibility with our products ECOCLEAN and VIVA brazil have been tested and found to be harmless to the acrylic. We assume no liability for damage to the acrylic shields caused by chemical products of other manufacturers.

Important things to know before tanning

The irradiance output of this solarium has been calibrated for optimum effectiveness. Only the highest quality reflector lamps and acrylic sheets are employed to provide the best possible tanning performance at maximum UV-transmission levels. The "Te / Tm" (Time to Erythema relative to Time to Melanogenesis) has been precisely formulated and expressed in the recommended maximum exposure schedule (MED), which should never be exceeded.

In both commercial and residential application, the user should consult his or her physician about indoor sun tanning and its effects on their condition before using this solarium. Persons taking prescription medications must always take care that such substances do not increase the level of sensitivity to UV light, and may not tan if any warnings are issued by their respective manufacturers or the prescribing physician.

Instructions on Tanning

Those persons who (1) do not tan in the natural sun or have type 1 skin (see warning label on unit), (2) are under 16 years of age - without written parental consent, and (3) are currently taking photo-sensitive medications or are afflicted with skin disorders or skin cancer, may not tan in this solarium.

The preset distance between the canopy and bench may not be altered for any reason.

Please read and observe the information outlined in the warning / danger labels and recommended exposure schedule.

Do not use this machine if any of the face tanning filter glasses is cracked or broken.

Overexposure of ultraviolet-radiation from the sun and this machine can cause sunburn, as well as damage to unprotected eyes.

Unusually frequent exposure to ultraviolet-irradiation from sunlight or this machine can cause premature aging of the skin and skin disorders.

High levels of UV-radiation can cause infections and damage the retina of the unprotected eye. Cataracts can also be caused by repeatedly exposing the unprotected eye to UV-radiation.

Special care should be taken to insure that medications taken or cosmetics worn during tanning are not UV-sensitive.

As such the following precautions must be taken:

- Always use the included protective goggles;
- Remove all facial cosmetics and paba-based SPF before tanning in this machine;
- Do not tan in this machine if you are taking medications that may cause your system to become UV-sensitive. Consult your physician prior to tanning;
- Always wait at least 48 hours between tanning session. Never more than once per day;
- Always observe the warning / danger labels as well as the exposure schedule;
- Always consult you physician should skin swelling, lesions, or "liver spots" appear on the skin.

Exposure schedule

The recommended exposure schedule has been indelibly adhered to the front of the canopy, and should be followed explicitly.

The MED (Maximum Erythral Dosage) or maximum tanning time may not be exceed.

Exposure distance

The distance between the canopy and the bench may not be altered for any reason.

For commercial operators:

1. No one under the age of 16 should be allowed to tan without the express, written consent of a parent or guardian.
2. The distance between the lamps and an individual tanning in this solarium has been preset, and may under no conditions be altered or lessened.
3. UV radiation can cause damage to the skin and eyes. Insure that you and your staff have been properly trained by a state or provincially - authorized educational organization to give adequate usage instructions to tanning customers.
4. Obey the contents of the danger and warning labels affixed to the solarium, and do not attempt to override the MED (maximum exposure dosage) session times.
5. Insure that all users of this solarium are given eye protection, of the type approved by your respective state's or province's health and / or radiological control agency, and insist that they be used at all times when the unit's lamps are lighted.
6. Instruct all users to remove any make-up or facial cosmetics before using the solarium.
7. Be sure to not allow any individual to tan more than once during the course of a 24 hour period.
8. Do not allow any individual to tan should they appear physically sick, disoriented, under the in-

RECOMMENDED EXPOSURE SCHEDULE		MAXIMUM EXPOSURE TIMES (IN MINUTES)			
CLASS:	SKIN TYPES:	week 1	week 2	week 3	MAX
I	SENSITIVE SKIN (Burns easily and severely, and does not tan.)	TANNING NOT ADVISED			
II	LIGHT SKIN (Burns easily and severely, and tans minimally.)	2	4	6	8
III	NORMAL SKIN (Burns moderately, and tans modeately.)	3	5	7	9
IV	DARK SKIN (Burns minimally, and tans well or above average.)	4	7	8	10

Most coin boxes and external controllers do, however, have connectors for the fan-on delay. Should these be used, the time period can be lengthened on an individual basis. This can be useful when encountering temperature problems due to an inadequate or excessive ventilation situation.

The „Lag Relay“ after-cooling timer can also be connected to this terminal, at pole No. 1 (red wire).

Please note:

The solarium is initialized by setting the entry time at 0 volts = Gnd, either by relay contact or the so-called open-collector output admittance.

In this type of switching, the additional fan-on delay feature does not need to be connected because the internal additional fan cooling is activated.

Interconnection of the electrical components

An overview of the arrangement of lamps and lamp ballasts is shown below.

The complete schematic overview indicating all terminals, sockets and plugs required for system connections is shown on page 18.

The lamp ballasts are installed in the pedestal on the right side next to the control unit at a total of 8 plug-in module mounts. The lamps in the upper and lower segments are connected via these module mounts.

Please note: The plug-in module mounts are insulated to reduce leakage current from the grounded base and thus may conduct voltage.

The plug-ins E1-E8 are arranged from front to back according to function:

- E1, E2: for 8 each lamp ballasts 160 W for the bench unit
- E3: lamp ballasts 160 W for the bench unit + 6 x 25 W for the shoulder tanner
- E4-E7: 8 each lamp ballasts 160 W for the canopy lamps
- E7-E8: plug-ins for facial tanner lamps, 4 each lamp ballasts at 140 W + 2 each lamp ballasts at 80 W.

Connecting time-control units / coin boxes with remote start capability

During the operation period after the coin box has been activated, the user can individually start the tanning process. While in standby, the START/STOP button creates a remote signal that initiates the tanning process. The solarium has a floating relay contact which closes for about 1 second as soon as the START/STOP button is pushed. If the time-control unit is programmed accordingly, the tanning process will commence immediately. The receptors for the remote signal are located on the three-pronged plug (fig. 15) next to the coin box plug.

Connecting a low-voltage time-control unit

There are also time-control units / coin boxes whose relays don't allow high voltages. These controls are attached directly to the relay board. This board is located inside the control unit under the cover plating. Remove this plating by removing the fastening screws. Interconnect the four-pronged plug according to the following diagram:

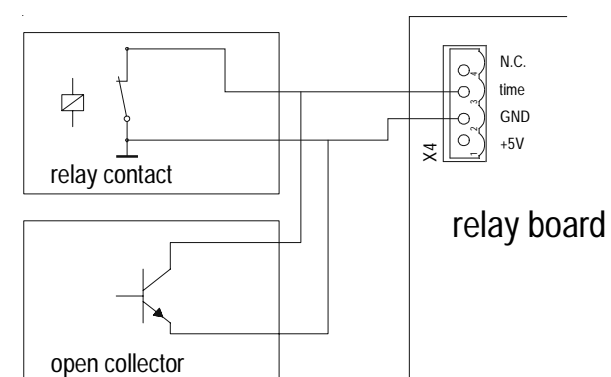

As a total, the plug-ins contain 64 auxiliary devices: 46 x 160 watts for the bench unit and canopy, 6 x 25 watts for the neck area tanner, as well as 8 x 140 watts and 4 x 80 watts for the facial tanner.

The facial tanners are controlled by 3 each auxiliary devices, 2 x 140 W = 280 W for Setting 1 and 2 x 140 W + 1 x 80 W = 360 W for Setting 2.

Connecting to the main power supply

Cable conduit connection

Route the power cord with the cable conduit through the 1,4" sized hole on the back to the power supply terminal and attach it according to the designation on the terminal label. Fix the conduit with the cable clamp provided on the left at the rear of the mounting plate.

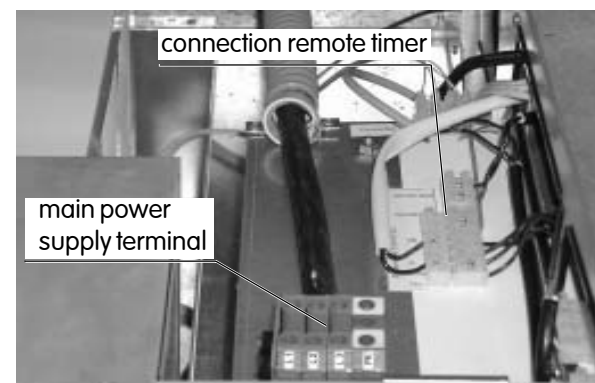

Please notice that the electrical connection of the solarium was designed in 220 V 3-phase at the factory. If required the wiring has to be changed into 220 V single phase according to the wiring-diagrams below during installation in the salon.

1. Connection: 220V 3-phase

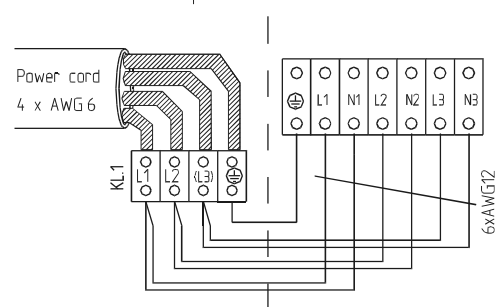

2. Connection: 220V single-phase

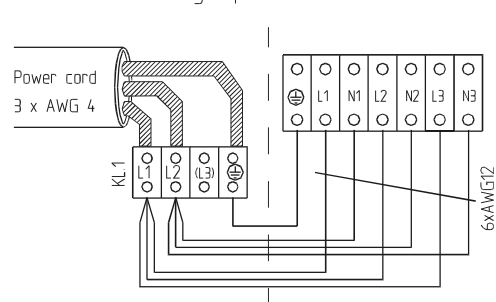

Remote control

Your solarium can be easily connected to a remote timing device by connecting the switched phase leads to the poles 2 and 4 of the 6 pole terminal, which is located on the left hand side of the controls. Remove and isolate the wires, connected to pole 2 and 4, which are needed for normal builtin-timer operation.

The connection of the remote switch is shown in the following diagram. Use a cord type SJT or equivalent, with a maximum length of 25 feet.

Notice:

In accordance with the maximum exposure limit of 10 minutes, the maximum running time of the remote timer should not exceed 10 minutes.

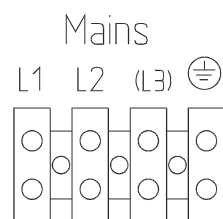
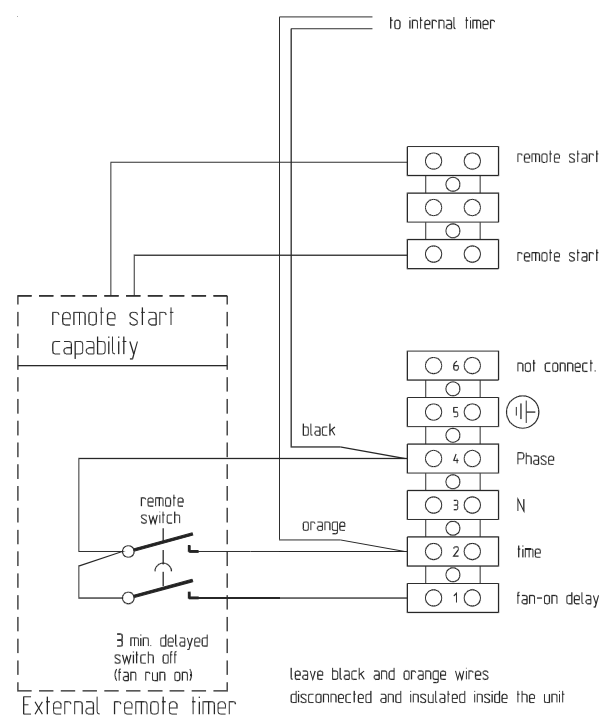

Fan-on delay

For cooling purposes, it is always necessary that the fans run an additional 3 minutes or more after every tanning session. This extra period of time is part of the solarium control programming and cannot be shortened.

influence of alcohol, or display signs of swollen or infected skin. Insist that any such person goes immediately to their physician if they complain of injuries or burned skin before or after tanning.

- Recommend to your customers that they apply a moisturizing lotion after tanning.
- Make sure that there is enough room to move the parts of the machine into the cabin, and that there is sufficient space in the cabin itself for proper installation.

After tanning

It is advisable to apply a moisturizing lotion on the skin after tanning.

Electrical requirements

The electrical requirements for all single phase 220 Volt combinations are:

- 220 Volt dedicated circuit
- 4 AWG SJT Power Cord
- 70 Amp rated breaker

For 3-phase mains supply the electrical requirements are

- 220 Volt dedicated circuit
- 6 AWG SJT power cord
- 50 Amp rated breaker

Operating any 220 volt combination at voltage levels below 220 or above 240 constitutes an automatic nullification of the warranty, as it could cause damage to the unit's system.

Please insure that your electrician and / or installer reads this information prior to delivery and setup. Using a digital volt meter, he or she must first determine the exact line voltage being delivered to the receptacle. If the line voltage is not within the specified range, employment of a buck-boost transformer will be requested to regulate it. Please contact your authorized DR. KERN dealer for pricing and availability on buck-boost transformers.

Primary timer

If the solarium is used in a residence, without being connected to a commercial remote timer, it can be activated by turning the external timer knob to the desired tanning time.

After the clock operated switch has run out, the lamps will automatically shut off.

The primary timer is located on the right of the operating panel.



System operation and control

The solarium is operated via the console integrated in the movable part of the canopy. From there all information and chosen options are sent to the control unit in the pedestal.

The control unit circuitry contains all necessary functions one would expect in a high-performance solarium. The circuitry is designed for fail-safe and non-maintenance operation. For example, should there be a failure in the operation circuitry, the unit can still be operated from an external timer-control, since the solarium functions are controlled by electromechanical operating elements. This prevents the unit from breaking down.

The features of the console are as follows:

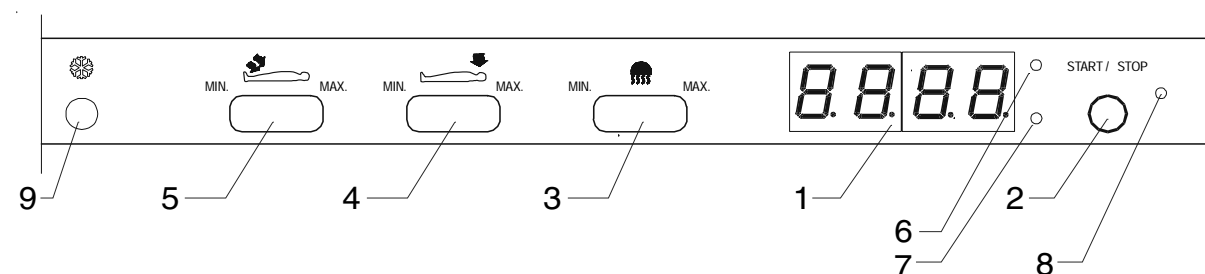

Console Features

1. 4-digit display indicating total tanning time
2. Start/stop button for manual activation/deactivation during operation
3. Switch for facial tanning intensity
4. Switch for ventilation intensity in the facial area
5. Switch for ventilation intensity in the torso and leg area
6. LED-display for operation
7. LED-display for STOP
8. LED-display for malfunction
9. Air conditioner display

Feature description

1. Display:
The display is activated when the solarium is turned on and shows the tanning time in minutes and seconds.

2. Start/Stop-button:
An attached coin box or external time-control unit can be activated via this button. This "remote-start" initializes the tanning process immediately, assuming the coin box supports this feature. During the time allotted by the external controller, the lamps can be activated and deactivated by pressing this button.

3. Switch for facial tanning intensity:
The intensity of the facial tanning can be altered using this switch, which has three settings (I, II, III), whereas setting I is about 2/3 of maximum intensity.

Please note: should the facial tanner be deactivated during operation, there will be a reactivation delay of approximately 1 minute.

4. & 5. Switch for ventilation intensity:
This switch controls the ventilation intensity. Cooling for head and body/feet are controlled separately, and each have 3 intensity settings (I, II, III).

6. LED-display for air conditioner:
When air conditioner is enabled, the control LED will be lit. The actual switch for activation/deactivation is located over the control unit inside the pedestal.

8. LED-malfunction display:
This yellow diode blinks when the external timer-control has been enabled, yet the tanning lamps are not running. This can happen, for example, if the central fan is malfunctioning - the tanning lamps are then deactivated to protect the solarium from overheating.

Frame rack

1. Tilt the frame rack onto the back of its castor units so you can reach the screws located on the underside of the rack.
2. Now remove the connecting screws from both facing mounts connected to the heavy-duty castors (outside) and remove them.

Please make sure that the castors as well as the adjustment levers are not disassembled in the process.

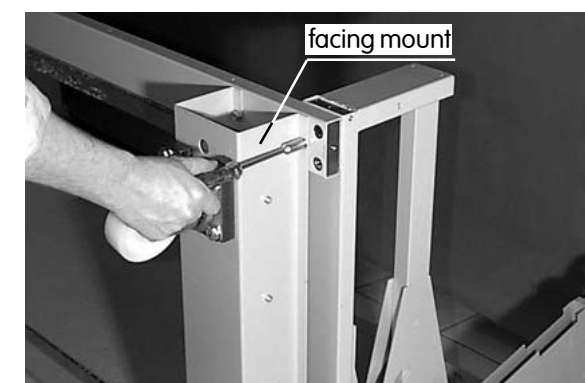
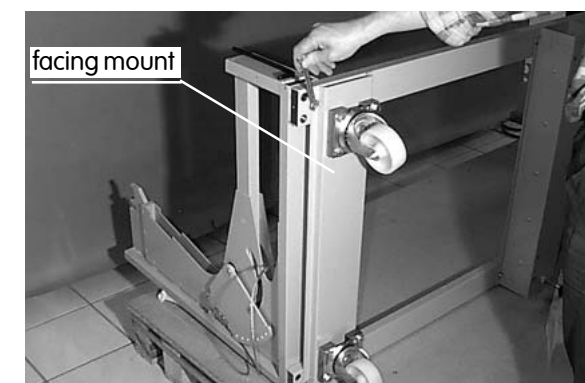

3. Disconnect the front and back longitudinal beam from the stands. Do this by removing all 8 screws (hex head M12, SW 10) from the corners.

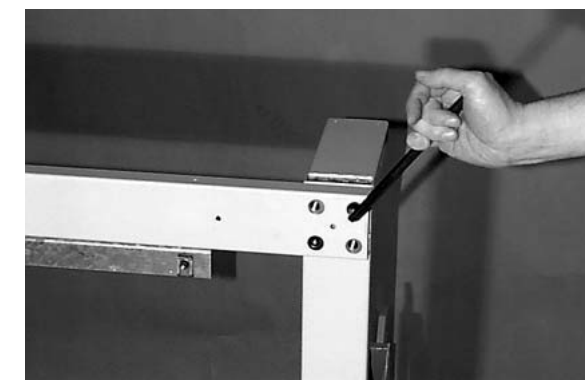

Please note:
The frame rack must be positioned at a 2,5 degree angle (from the base, left side) during reassembly. This should automatically be the case due to the weight of the heavy-duty castors, but should be monitored nonetheless.

Disassembling the solarium before installation

Back wall

1. Unscrew the 2 connecting screws from the crossbar between the canopy seating plates (Allen key SW 8).

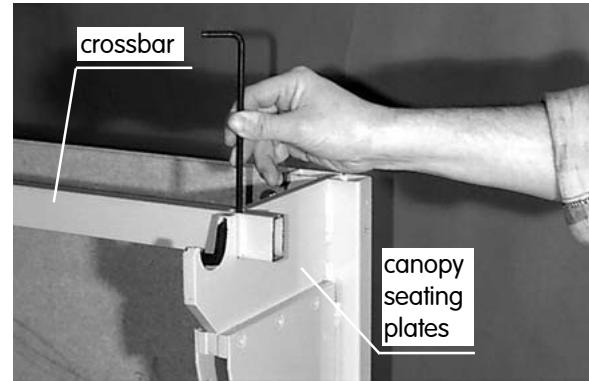

2. Now remove all fastening screws holding the back wall in place (4 per side, hex head screws SW 13).

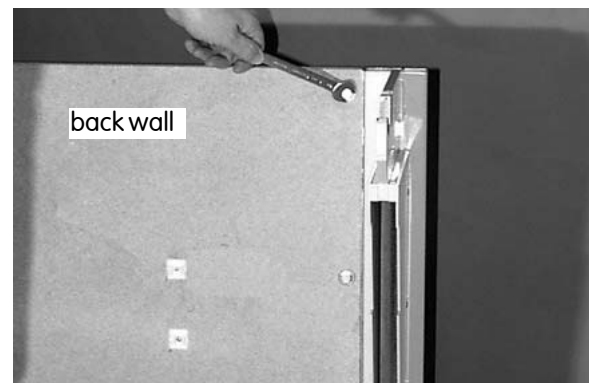

3. Tilt the upper part of the back wall forward and lift it out of the pedestal.

Please note that the frame rack is outfitted with 4 heavy-duty castors so the system can be moved slightly within the cabin for better handling of the back wall.

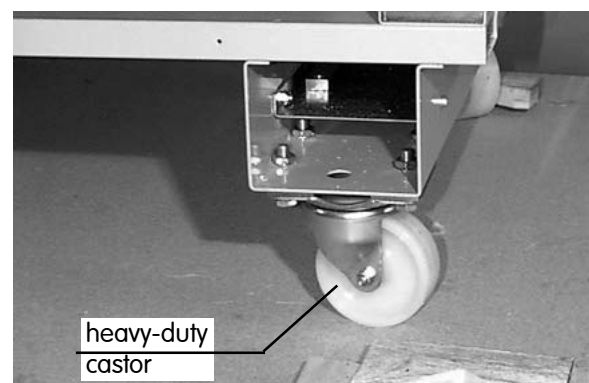

Base plate

1. Unscrew all 4 fastening screws (4 hex head screws, SW 13) and lift the base plate upwards out of the unit.

Please be sure that the facing mounts for the ballast unit are left attached to the base plate.

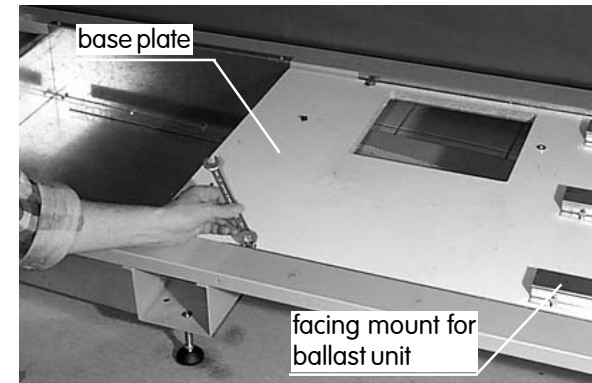

Assembly unit, air conditioner

1. The assembly unit for the air conditioner is located on the left hand side of the pedestal area.
2. Remove all connecting screws from the frame rack and lift the unit out of the frame rack.

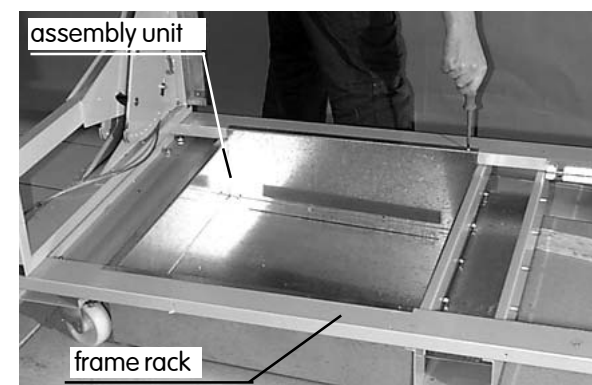

Recommendations for exhaust system placement

The exhaust of the sunbed must be vented out of the cabin through a hose. In addition, it is necessary to ensure sufficient make-up air in the cabin.

Please note the following regarding the venting of exhaust air:

Outside temperature

The outside temperature has a great impact on unit operation (also see "Important Notices..." on page 3). This is especially true for the hotter summer months. A cabin air-conditioning system should be considered for this time period.

Air-inlet vents

The calculations shown below derive from a minimum recommended set-up area of about 67 sq ft. Adherence to these dimensions allows for an effective opening large enough to admit an adequate amount of air into the inlet area. Please note that privacy panels, screens, etc. in the air-inlet area can reduce the overall throughput, resulting in loss of air flow.

Cabin ventilation

Apart from optimal venting, it is also important that an adequate supply of fresh air is introduced into the cabin. The air-inlet vents in the effective wall should therefore be larger than the air-intake slots in the solarium to avoid undesirable drafts.

A cross section of 700 sq in should be provided. It is also recommendable to position the air-inlet vents on the lower sections of the cabin walls.

Exhaust hose placement and hose diameter

A hose with a diameter of 16 inches should be used for this solarium.

In addition to the diameter, the placement of the hose is also very important. Ideally the hose should lead away from the unit in a straight line. Every bend in the hose increases the air resistance within it. 180-degree bends should generally be avoided.

If one or more bends are necessary, please note that this reduces the overall length of the hose unless a booster fan is used.

A hose length of about 12 feet placed in a straight line without a booster fan may be used.

Therefore, when using a long hose with many bends, it is highly recommendable to use an additional fan in every case. The exit cross-section of the hose should under no circumstances be reduced because an air jam will occur otherwise.

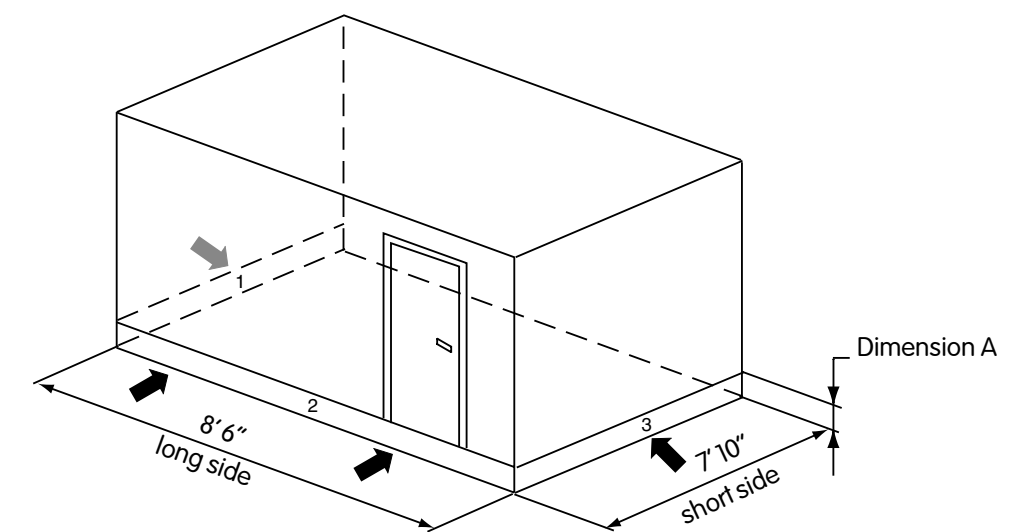

Minimum dimensions of the air-inlet vents	
Dimension A with one cabin wall open, long side	8"
Dimension A with two cabin walls open, long and short sides	4"
Dimension A with three cabin walls open, long and two short sides	3"

Maintenance

Replacing the Lamps and Starters

The longevity of the fluorescent lamps vary from manufacturer to manufacturer, but is usually between 500 and 800 hours of use.

Only authorized, original parts and factory components can be used in this machine; please make sure to have your model type and serial number available when ordering these from your DR. KERN distributor.

THE FOLLOWING LAMPS HAVE BEEN CERTIFIED FOR USE IN THIS EQUIPMENT:

Canopy: High Pressure Lamp Dr. Kern 400 W
 Canopy: Cosmedico VHR 160 W
 Bench: Cosmedico VHR 160 W
 Bench: Cosmedico UVA plus 25 W

Disconnect the solarium before performing any work on it. The acrylic sheet in the canopy and bench must be removed to replace the lamps and starters.

UV lamp and starter replacement in the solarium bench

First, open the solarium bench by sliding the ergonomically formed acrylic plate up. Do this by placing your hand under the front end of the plate and pull it upward.

Due to the catch in the rear area, it latches into place and will remain in the open position.



Now, remove the thinner acrylic plate positioned beneath it by grasping it by its sides and lifting it upwards out of its holders. Remove the plate towards the front side of the solarium bench unit.

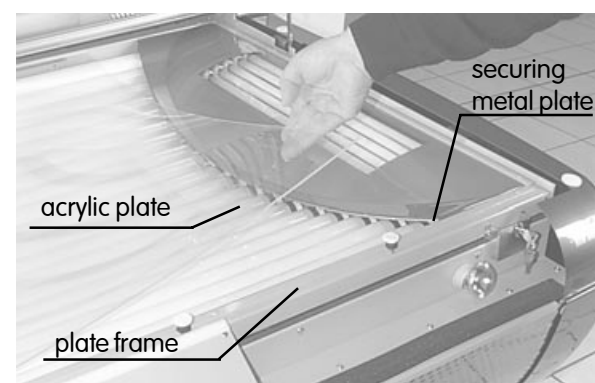

Before changing the lamps you must first remove the shielding at the head and foot ends of the lamps. These are simply lifted upward out of the bench unit.

Before doing this two small securing metal plates mounted to the support of the thinner acrylic plate on either ends must be unscrewed and removed.

This securing metal plate must be replaced after service.

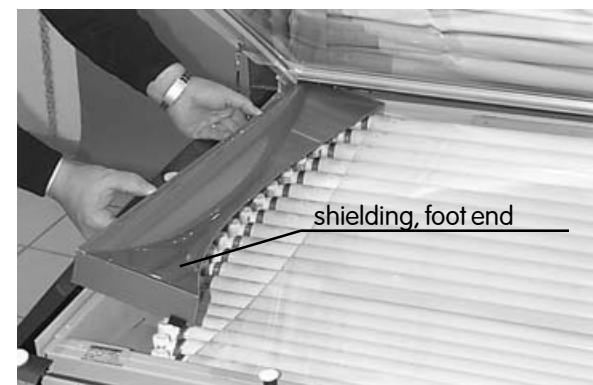

The UV low-pressure lamps are removed and replaced by turning them 90 degrees in their holders at their head and foot ends. When inserting new lamps, make sure the contact pins are securely inserted into the holders.

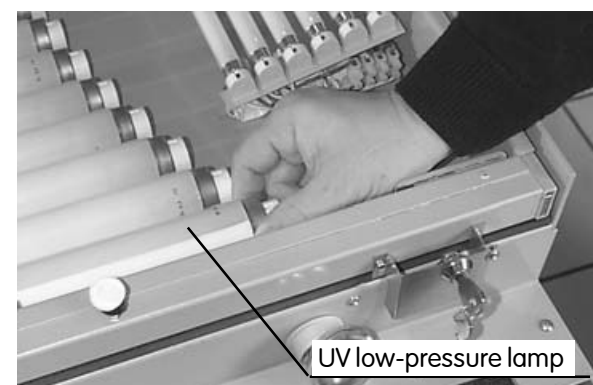

Disassembling the solarium before installation

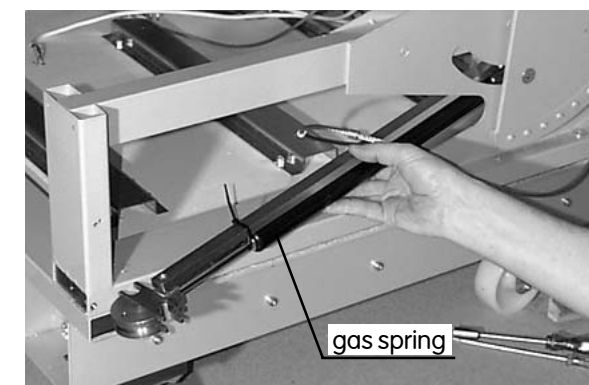

8. Remove the preloaded gas springs in an outwards direction.

9. Unscrew both lifting rods (2 on each side) out of the yokes on the canopy.
(Note: Release the safety nut).

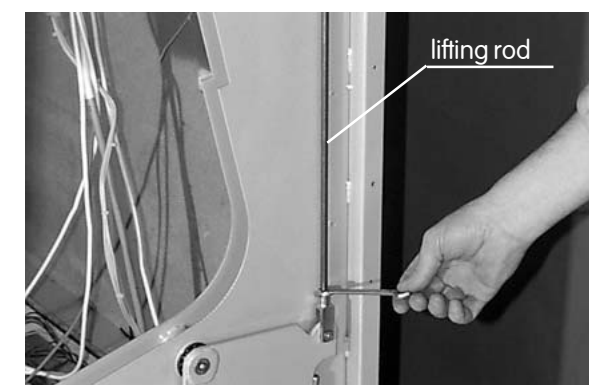

10. Slide the canopy open as far as it will go and then lift it out of its bearing point.

When space is limited (e.g. during transport) it is highly recommended to completely disassemble the pedestal frame unit. This process is described in the following sections.

Central fan

1. To disassemble the central fan you must first release the air shaft connected to the back wall of the pedestal. Do this by unscrewing the 6 lateral fastening screws.

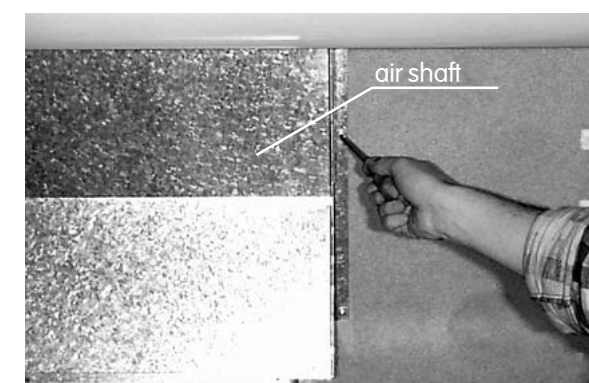

2. In addition, all lateral screws holding the control unit in place in the front area and the control unit itself have to be removed.



3. Now remove the metal cover plate over and in front of the fan.

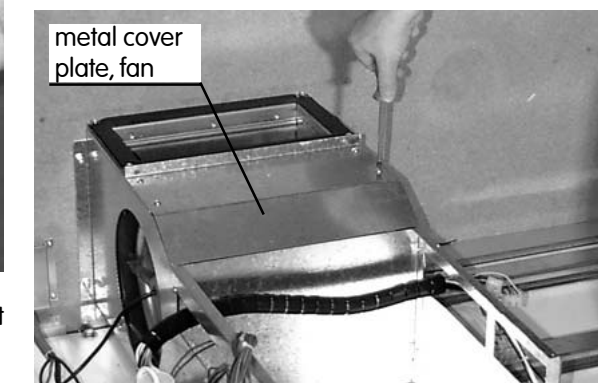

4. Afterwards, unscrew the fastening screws holding the fan in place and lift it upwards out of its housing.

Please note that the disassembly of the fan requires the disconnection of the electrical connection.

5. Now you must remove the bolted joints from the side walls of the rear housing for the fan (fan seating) and frame rack. The side walls can now be removed from the pedestal.

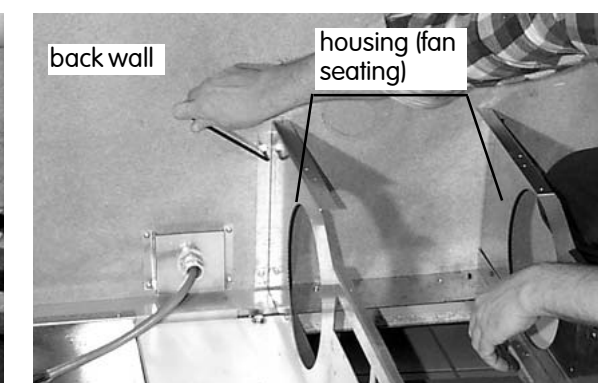

Disassembling the solarium before installation

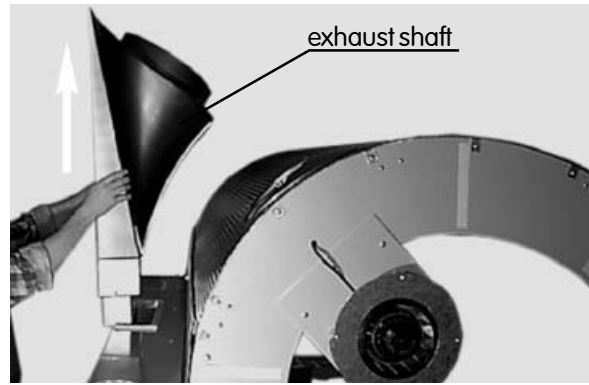

Please note that the lateral plastic pedestal casings are included in the package to protect the unit from possible damage during transport.

Later, the casings are attached to the head braces (special bonding for outer casings).

- Now swing the canopy into its open position.
- Hinge the gas spring locking devices into the rear end-piece of the gas spring on both sides.



- Pull the canopy down until the gas spring locking devices can be hung into the screws on the front curved segments. Insert the cable binder into the latch to keep it from coming open again.

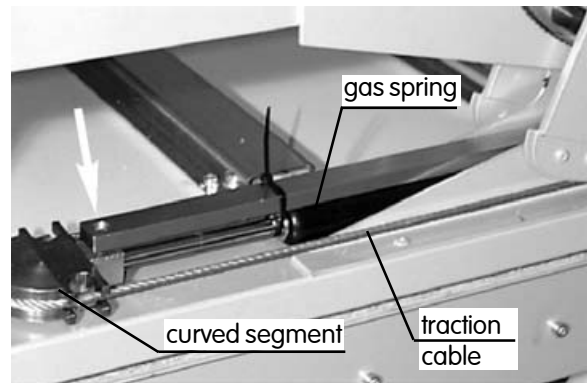

- Slowly reopen the canopy to ease tension in the traction cables on either side.
- Unhook traction cables from the curved segments on both sides. To do this, remove the pressure-sensitive bushings from the cable safety lock in the front area of the gas spring.

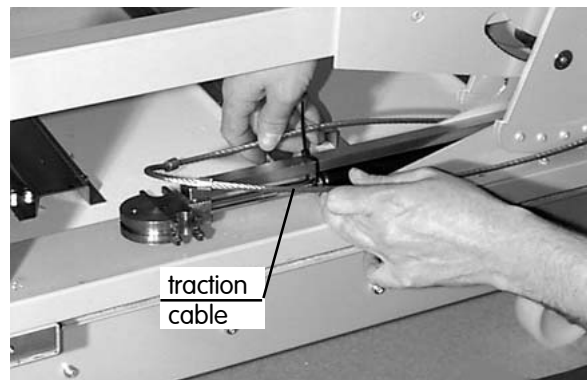

- Release the fastening screws in the upper metal cover panel of the hot air recycling shaft.
- After lifting the cover panel, disconnect all hose brackets in the hot air recycling system.

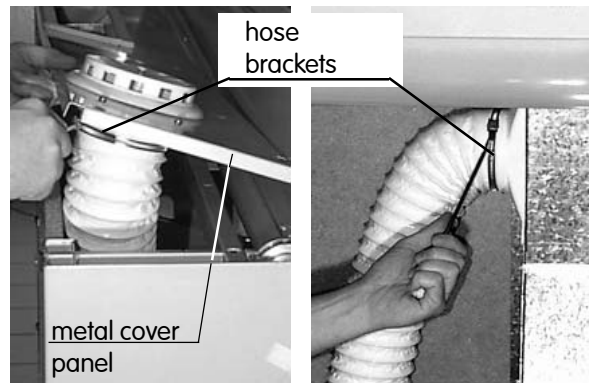

Canopy

- Before unhooking the canopy, unscrew the painted head braces on each side of the stands supporting the frame unit. To do this, remove the outer cover panels by unscrewing all metal fasteners arranged in an arch.

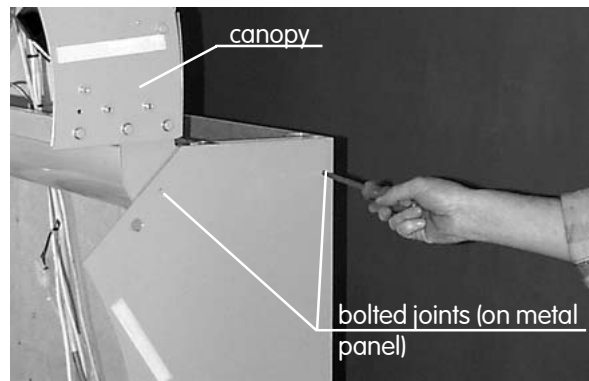

- Now you can reach the actual connections between the head braces and stands on the right and left hand side (flat countersunk head screws in the front and rear areas). Release these and remove the head latches.

Maintenance

The starters are located at the foot end of each lamp and can be removed and replaced by turning them 90 degrees.



The decorative light is located on the outer right-hand side. To remove it, turn it counter-clockwise out of its E14 socket.

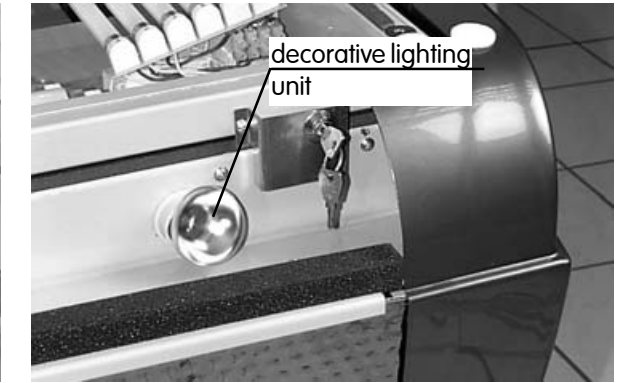

Insert the new light following these instructions in reverse order.

UV lamp and starter replacement in the shoulder tanner

Additional UV low-pressure-lamps (25 W) and their corresponding starters are located in the shoulder area beneath the head end shielding.

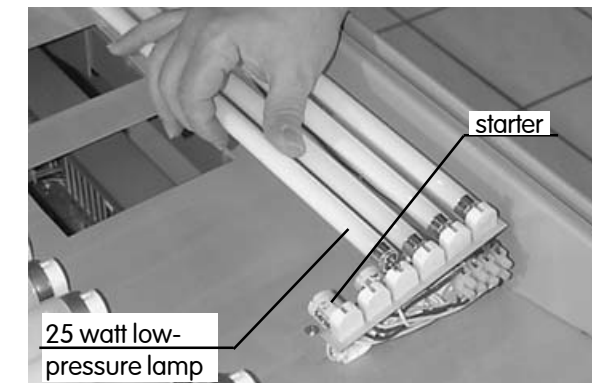

Replace the lamps and starters here also by turning them 90 degrees and then lifting them upward out of their respective holders.

Lamp replacement in the decorative lighting unit

The decorative light is located in the forward area below the ergonomically formed acrylic bench plate. The decorative light is always on when the unit is not in use. During the tanning process it is automatically disabled.

To replace the colored bulb of the decorative lighting unit, slide the ergonomically formed acrylic bench plate open.

UV lamp and starter replacement in the canopy

When performing maintenance on the canopy, always raise it so it is in the open position.



Now remove the fastening screws on the right and left hand side of the pane frame and unlatch it by pushing the locking bolts over the fastening screws on each side towards the middle of the unit.

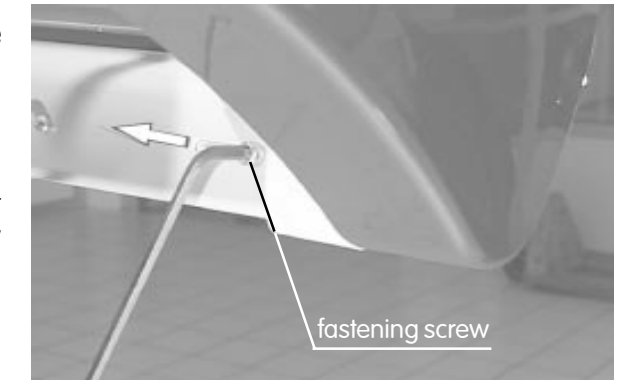

Maintenance

Then swing the pane frame downward and lay it on the bench.

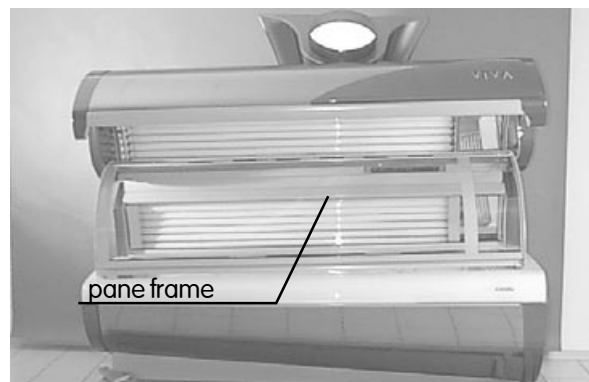

Here also the UV-low-pressure lamps are removed and replaced by turning them 90 degrees and lifting them out of their sockets at the head and foot of the unit.

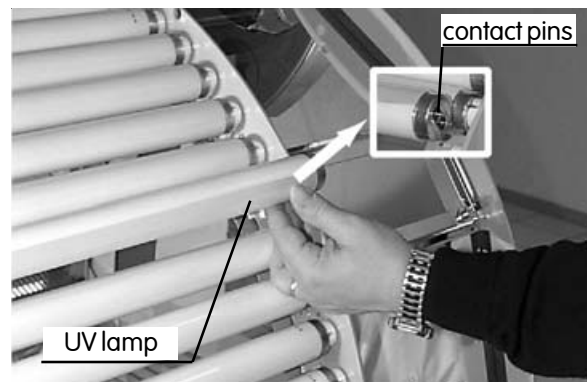

Always make sure the contact pins on the lamp ends are correctly inserted into the sockets.

Afterwards remove the fastening screws on the lateral lamp frame locks.

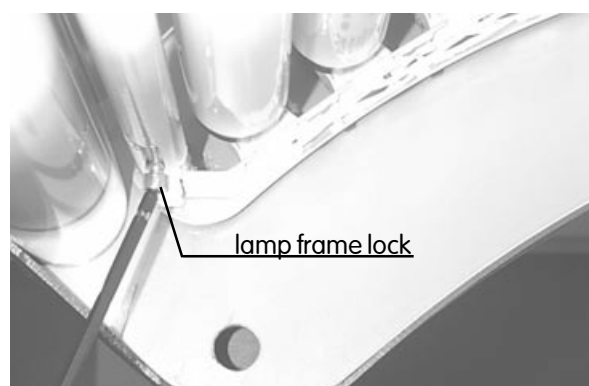

The starter is positioned at the foot end of each lamp. Remove or insert a starter by turning it 90 degrees.

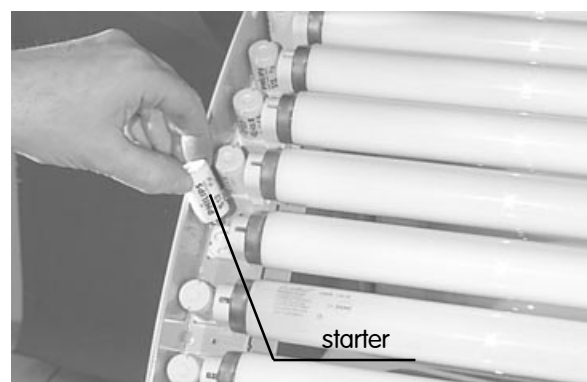

Move the locks towards the middle of the unit and swing the lamp frame down and into its open position.

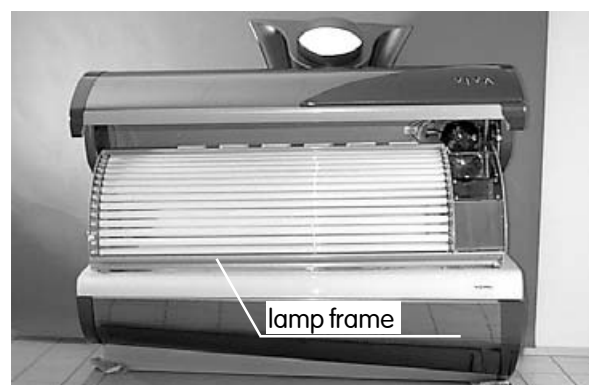

Now the lamp frame should be resting on the pane frame.

In this position all UV light sources in the canopy can be accessed.

Disassembling the solarium before installation

Air conditioner

1. The second step in the process of disassembling the air-intake shaft was to remove the intake cover panel, so you can now easily access the air conditioner itself from the front side.
2. The air conditioner is positioned between the unit facings and can simply be lifted from the pedestal. Before you do this, you must disconnect the electrical connections and disassemble the cold air supply shaft.

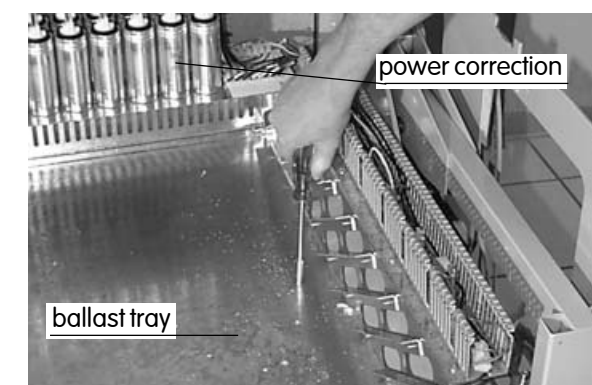
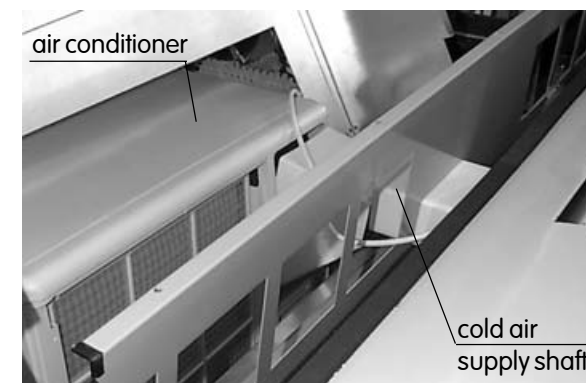

4. Afterwards, lift the receptacle out of its pedestal. Do not release the compensator unit in the rear area in the process.

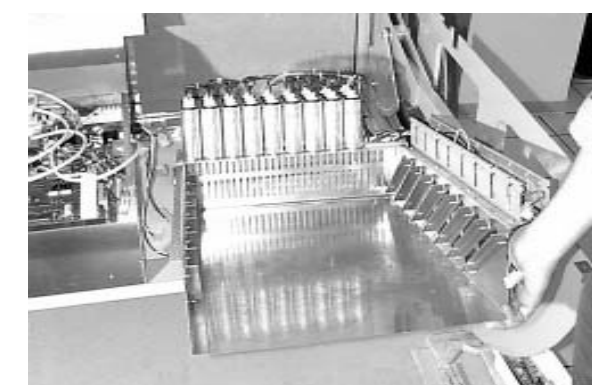

Ballast units / Power correction unit

1. All ballast units and capacitors for power correction are located in the right pedestal area. (capacitors+ 8 ballast plug-ins).
2. To remove the ballast units, unscrew the screws on both sides. Now the units (up to 9) can be lifted out diagonally.

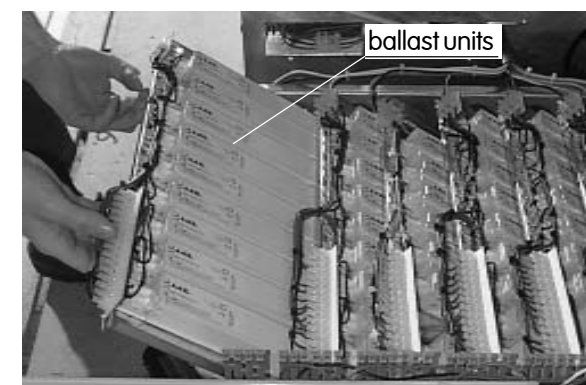

Hot air recycling / exhaust shaft

1. Remove the 4 fastening screws in the inner pedestal area on the exhaust shaft.

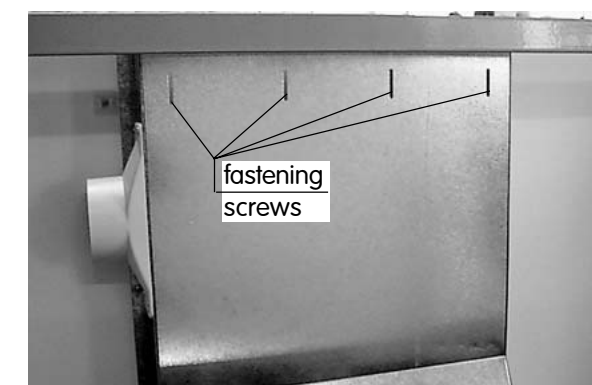

3. After disassembling each unit in sequence, beginning with the unit closest to you, remove the two fastening screws on the ballast tray. (Box wrench SW8).

2. Pull the exhaust shaft out with the lug facing upwards and remove it entirely.

Disassembling the solarium before installation

Air-intake, pedestal

1. Before disassembling the front and back air-intake cover, remove the filter mat from the intake area. It is not fastened to the unit and can simply be pulled out laterally under the cold-air shaft of the air conditioner and towards the front acrylic bench plate fans.
2. Now, remove the air-conditioning intake cover panel by removing the fastenings and lifting it out of the unit.

5. Release the connecting screws from the front metal casing covering the air-intake shaft and the interconnecting reinforcements.

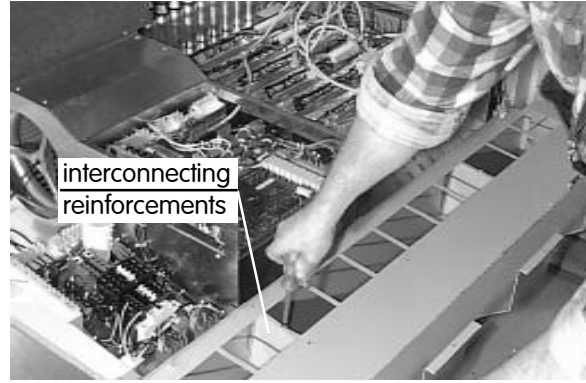

6. Afterwards, the front metal casing can be removed frontally.
7. To access the pedestal components such as air conditioner, central fans and ballast units easily, disassemble the lower painted pedestal panel with the attached interconnecting reinforcements. To do this, remove the fastening screws on both sides.

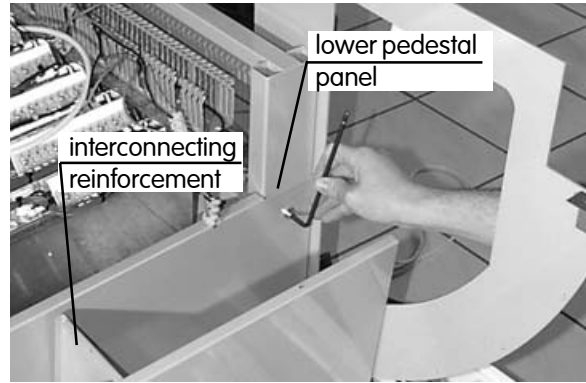

3. In addition, the metal cover panel over the controls in the middle pedestal area must be unscrewed.

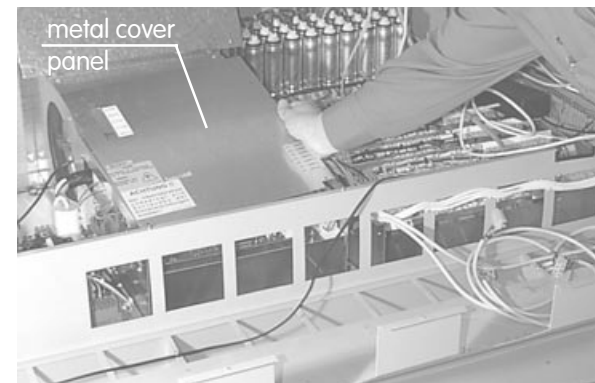

4. Now the back metal casing in the lower area can be unscrewed and pulled off.

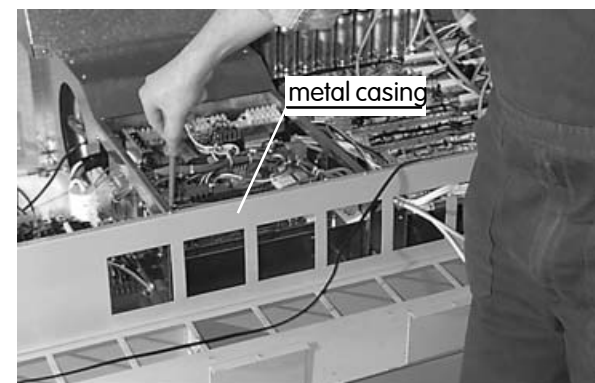

Maintenance

UV lamp and starter replacement in the lamp segment / pedestal

First loose and remove the securing screw of the lateral locks located behind the endcaps.

Then, disengage the narrow pane frame on the base by using a screwdriver to push the lateral locks on the bottom side toward the inside.

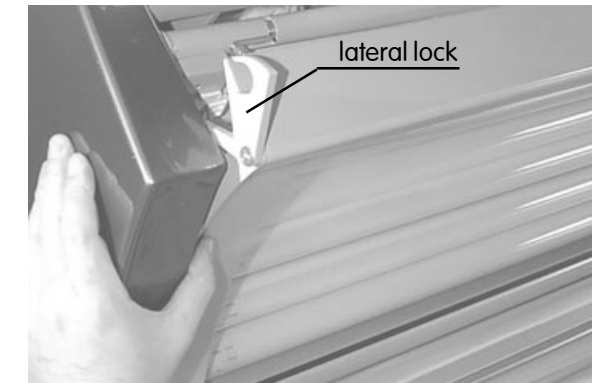

Now swing the pane frame forward and pull it upwards to remove it at the pivot points.

Finally, remove the screws on the lateral brackets and push the brackets toward the middle of the unit.



The lamp frame can now be swung onto the acrylic bench plate. Lamps and starters are removed or replaced from or into their sockets by turning them 90 degrees.

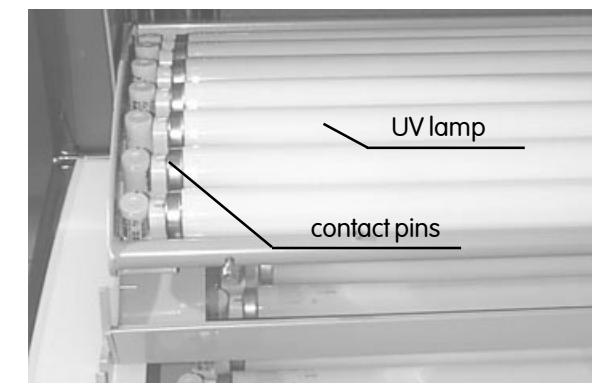

Metal halogen lamp replacement in the high-intensity facial tanners

To replace the metal halogen lamps in the facial tanners, the plate and lamp frame must be opened as previously described. This will allow direct access to the metal halogen lamps (400 W) in the center of the reflectors.



Please note: The metal halogen lamps used here have unidirectional sockets.

To remove the lamp, grasp the outer, flattened end and pull it from the socket. When inserting the new lamp, ensure that the contact pins are in the correct position before pressing the lamp into the socket.

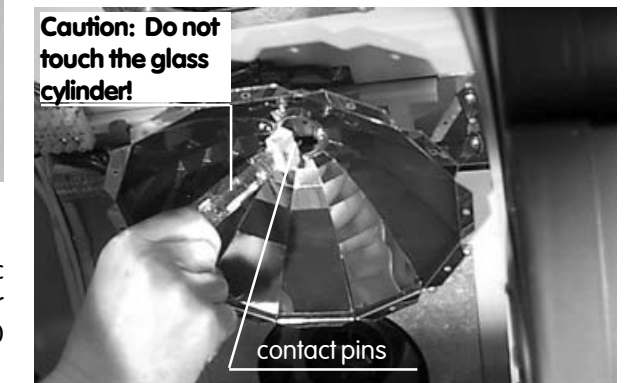

Please note:

Do not touch the glass cylinder when removing or inserting metal halogen lamps. Should this happen, the lamp must be cleaned with pure alcohol or spirit.

Removal of the filter plates

Pane and lamp frames must be unfastened and lowered as previously described in order to remove the filter plates.

To replace the filter plate, first remove the inside bolts on the filter plate mounting bracket. Now you can remove the bracket.

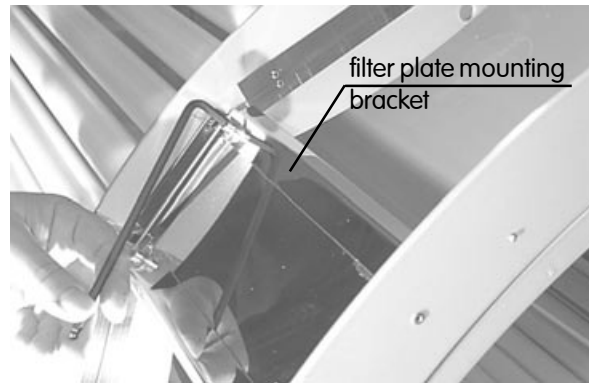

Now you can easily remove the filter plate from the mounting grooves on the other side.



Now you can easily remove the filter plate from the mounting grooves on the other side.

Please note:

The use of defective filter plates or plates not designed for the specified system can result in burns to the skin and is therefore to be avoided under any circumstances.

Use only original replacement parts (see equipment article number on the system identification plate).

Canopy unit lift system

The canopy unit is opened and closed with the aid of the gas-pressure spring system integrated into the right and left side panels. The gas-pressure spring system is preset in conformity with the draw-cable length at the factory and requires no further adjustment.

The gas-pressure spring system should be checked regularly to ensure long-term safety and proper operation of the solarium in accordance with applicable standards and regulations (sight and function checks).

For sight checks, the plate and lamp frames of the base segment as well as the acrylic bench plate and lamp bed must be raised so that a sight check of the fork heads, draw bars, wires, gas-pressure springs and bolt/screw connections at the mounting points on the base can be made. Components which may compromise safety should be replaced. Please contact your customer service department or local dealer in this case.

Cleaning the solarium

Use a moist cloth to clean the system. Do not, under any circumstances, use harsh cleansing agents on painted and decorative surfaces. A soap-and-water solution is sufficient.

The acrylic plates should be cleaned at regular intervals. Only solvent-free, non-caustic cleaners specifically formulated for acrylic panes may be used for this purpose.

Fan unit / bench in the pedestal

1. Remove the exhaust shaft in the forward pedestal area by unscrewing the self-tapping screws on the right- and left-hand side.

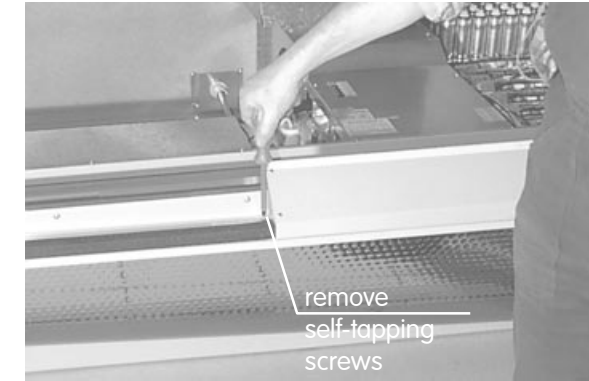

2. Afterwards, remove the inside metal casing covering the two cooling fans for the lamp area. Do this by releasing all screws from the front as well as the lower areas of the air-intake shafts.

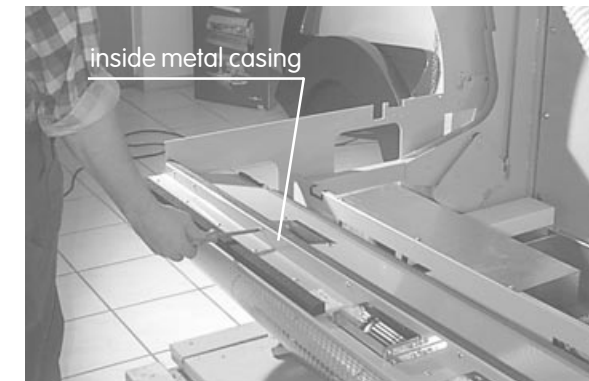

3. Release the connector for the fans at the attachment clips. Release the locking clips with a screwdriver.



4. Remove the cable for the decorative light.
5. Now, lift the metal cover out of the solarium.



Pedestal cover panel

1. To remove the front decorative panel, unscrew all fastening screws from the upper facing. In doing so, you simultaneously release the decorative panel and can thus remove it frontally.

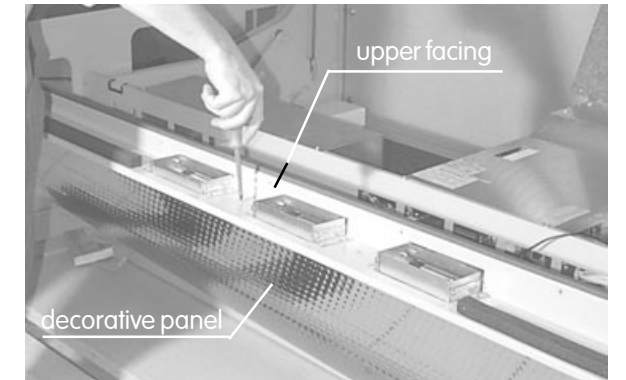

2. Afterwards, disassemble the reinforcement for the decorative panel by removing the lateral fastening screws.

3. After removal of the screws, you can remove the reinforcement by pulling it towards the front of the solarium.



4. Please note that 3 cooling fans are attached to the facing. Because of this, you must first release the fan connection cables at the attachment clips before lifting the facing out of the unit. The safety clips can be released with a screwdriver.

Disassembling the solarium before installation

Pane frame canopy

1. Unscrew the lateral interlocks and move each towards the middle of the solarium.

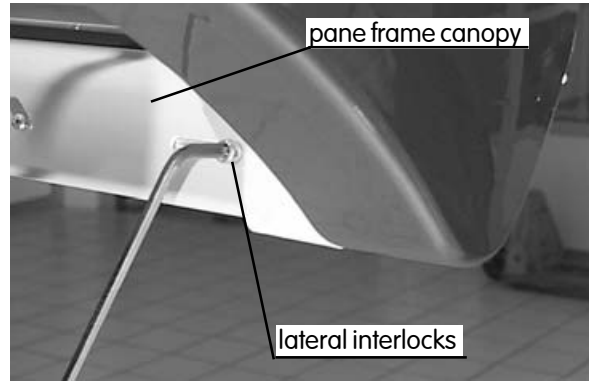

2. Swing the pane frame out and lay it on the pedestal frame.
3. Lift the pane frame from its seating while holding the pivot points and remove it towards the front of the solarium.

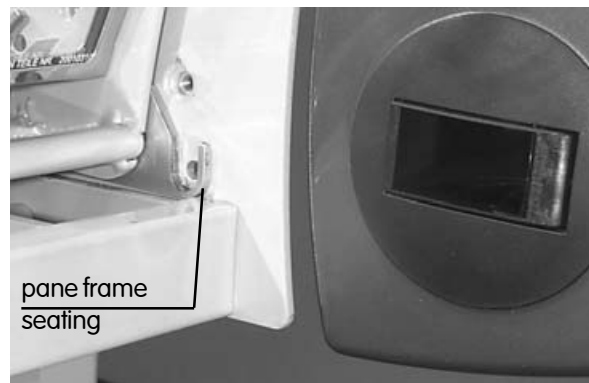
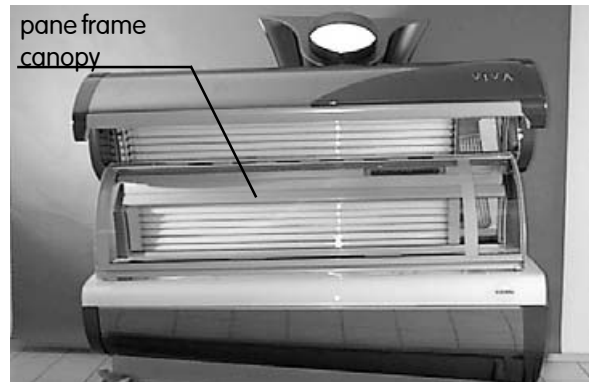

Lamp frame canopy

1. Remove the connection cable of the canopy from its slots. Release the locking clips here as well.
2. Unscrew the safety screws from the front latches with the Allen key (SW).

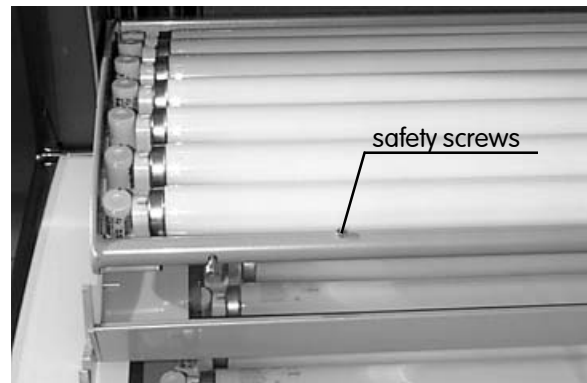

3. Slide the lamp frame down and out and lay it on the pedestal frame.

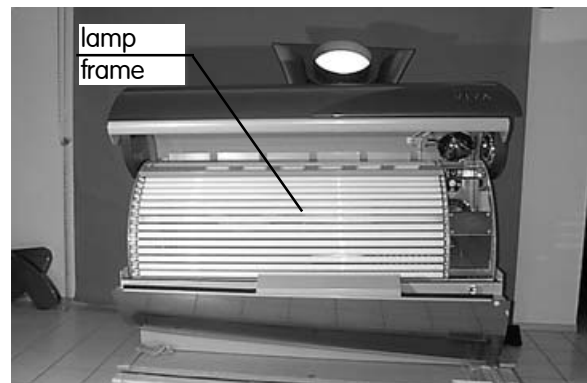

4. Remove the lamp frame and connection cables.
5. Release the filter mat from the pressure-sensitive tape

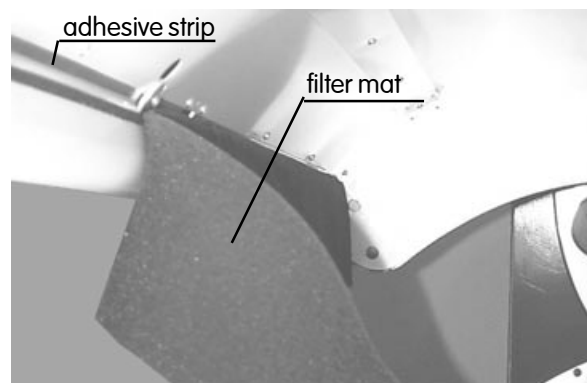

Maintenance

Replacing the filter mats

The air siphoned into the canopy unit and the base is drawn through filter mats in the area of suction. These mats should be replaced as needed when they have become excessively soiled.

To replace filter mats in the canopy unit, the plate and lamp frames must be pulled out and set down on the acrylic bench plate one after the other.

The filter mat is then pulled from the adhesive strips in the canopy unit and removed from the unit.

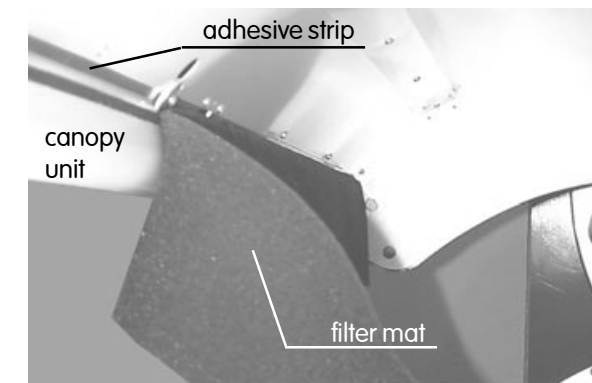

After the new filter mat has been pressed onto the adhesive strip and formed a bond, it is important to ensure that the filter mat is firmly clamped on the front section between the lamp and plate frames when the lamp and plate frames are raised.

To replace the filter mat in the base, raise the ergonomic acrylic bench plate and the lamp bed which is located below it. Please note that the lamp bed must be detached using the bar lock before it can be swung upwards (see following illustration).



Now remove the filter mat out of the exhaust duct.

Please note: Use only original replacement filter mats for the system. Filter mats other than those specified by the manufacturer may block air flow.

Filter mat replacement in the air-conditioning unit

In addition to the filter mats in the canopy unit and base, it is necessary to clean the dust filter screen in the air intake area of the air-conditioning unit from time to time depending on frequency of use.

To do so, it is necessary to raise the acrylic bench plate and the lamp bed. The system's air-conditioner is located to the left of the central exhaust unit.

First, remove the sheet metal casing over the air intake area of the air-conditioner by removing the screw/bolt connections and pushing the whole casing toward the rear.

Now you can pull the filter unit upwards and out.

The filter can be cleaned by vacuuming or, in case of excessive soiling, washed in lukewarm water (40°C).

Any moisture left on the unit must be thoroughly shaken free before the filter is re-installed using the same procedure in reverse.

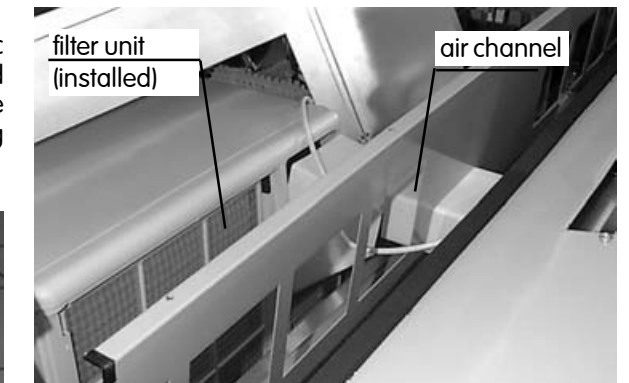
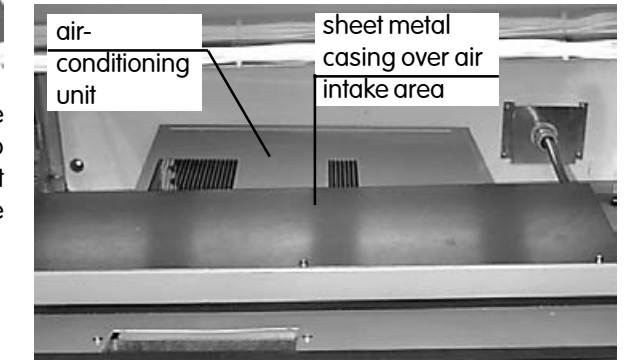

Disassembling the solarium before installation

Pane frame pedestal

1. Unlock the lateral latches by pushing them inwards on the underside with a screwdriver.

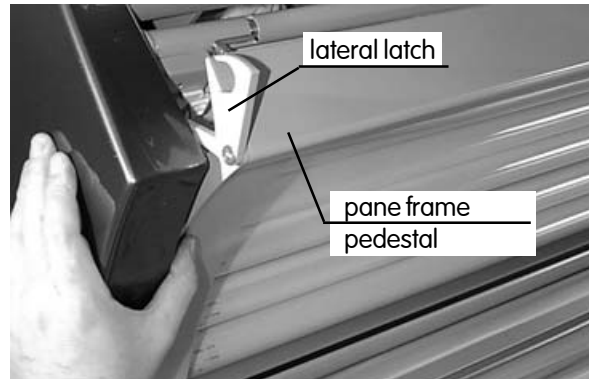

2. Slide the pane frame forward and lay it down on the acrylic bench plate.

4. Now, lift the acrylic bench plate out of its hinge joints with the inner frame facing forward.



Ergo - acrylic bench plate

1. After the previously described pane frame has been swung down, remove the rear bolted joints from the pivot points on the bench (Allen key SW 5).

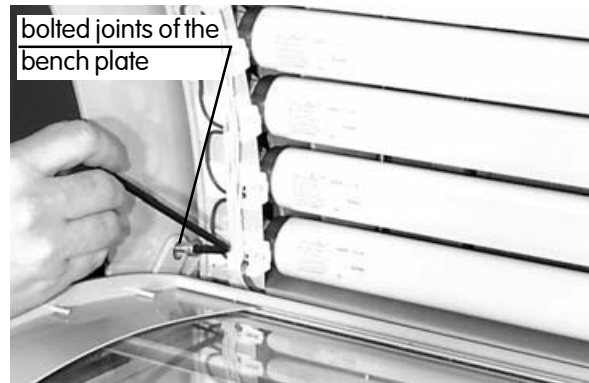

2. Afterwards, swing the pane frame pedestal back up and refasten it.

3. Before removing the acrylic bench plate, unscrew the safety lock holders on the pedestal braces on both ends.



Bench unit

1. Open the interlock on the right-hand side of the bench unit.

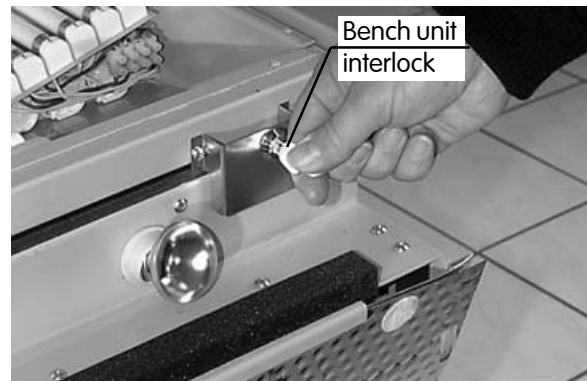

2. Slide the bench unit up.

3. Release the locking clips of the 3 front connectors from their slots with a screwdriver. Remove these plugs entirely.

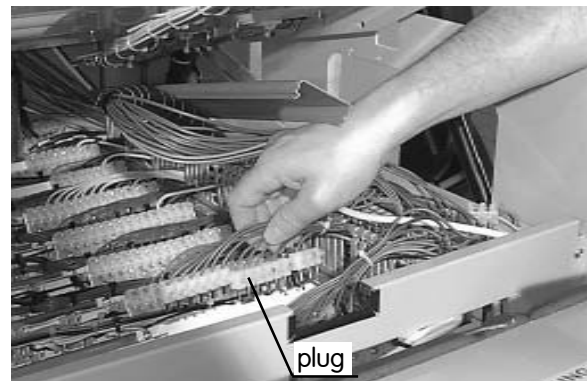

4. Slide the bench unit back down.

5. Release the gas pressure springs on both sides of the bench unit.

Disassembling the solarium before installation



6. Unscrew the protective fasteners on both sides of the unit.

7. Pull the entire bench unit out in the direction of the front of the assembly.

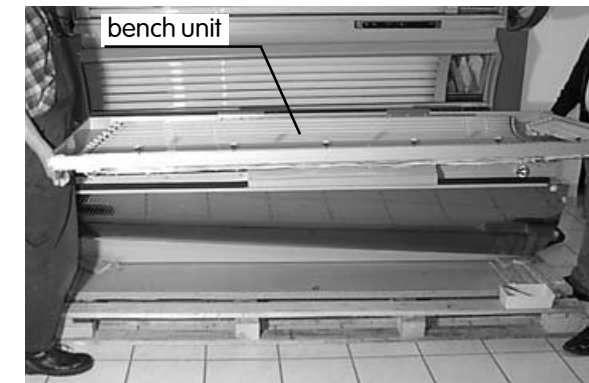

High-pressure lamp unit socket

1. The high-pressure lamp unit socket is integrated into the aforementioned lamp frame. Removing the connection cable of the lamp frame has therefore already severed the electrical connection to the slots.

Lamp frame pedestal

1. Release the lamp frame connector from the slot. Release the locking clips with a screwdriver.

2. Release the screws on the lateral safety locks (Allen key SW5).

3. Open the safety locks by moving them to the middle of the unit and secure them in this open position.

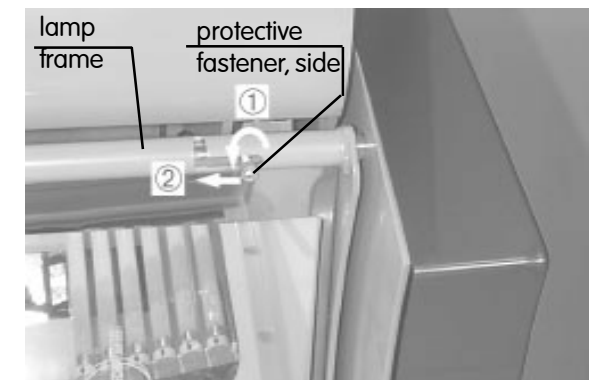

4. Slide the lamp frame forward and then up along the grooves of the hinge joints on the right and left. Carefully pull the connecting cables forward and out.